

User Manual

On-Line UPS Rack

15 kVA/20 kVA (3:1/1:1)

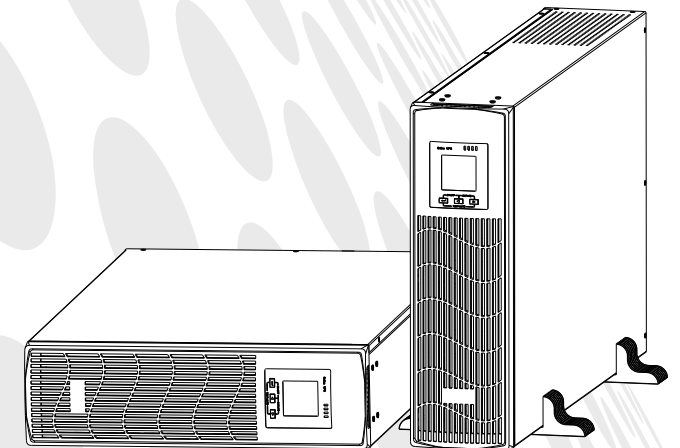

Table of Contents

Important Safety Instructions	1
1 Product Description	2
1.1 Electromagnetic Compatibility	2
1.2 Features	3
1.3 Models	3
1.4 Appearance	3
1.5 System Description.....	4
1.6 UPS Working Mode	6
1.7 Product Specifications	8
2 Installation	10
2.1 Unpacking and Inspection	10
2.2 Main cabinet installation	10
2.3 Connect Input/Output Power	13
2.4 Connect the Long Backup Time Model UPS with the External Battery.....	15
2.5 Connect Parallel Cables	15
2.6 Connect Communication Cables	16
3 Control and Indicators	18
4 Operation	26
4.1 Operation Mode.....	26
4.2 Parallel Operation.....	27
5 Communication	28
5.1 RS232 and USB Port.....	28
5.2 EPO Port	28
5.3 Intelligent Cards (Optional).....	28
6 Maintenance	30
6.1 Battery Maintenance.....	30
6.2 Battery Disposal	30
6.3 Battery Replacement Procedures.....	31
6.4 Precaution	31
6.5 Checking UPS Status	31
7 Troubleshooting	32
Annex Parallel Setting	36

Important Safety Instructions

Save these instructions

This manual contains important safety instructions. Read all safety and operating instructions before operating the uninterruptible power systems (UPS). Adhere to all warnings on the unit and in this manual. Follow all operating and user instructions. This equipment can be operated by individuals without previous training.

This product designed for commercial/industrial use only. It is intended for use with lift support and other designated “critical” devices. Maximum load must not exceed that shown on the UPS rating label. The UPS is designed for data processing equipment. If uncertain, consult your dealer or local representative.

This UPS is designed for use on a properly grounded (earthed), 220 / 230 / 240 Vac, 50 or 60 Hz supply. The factory default setting is 220 Vac / 50 Hz. Installation instructions and warning notices are in this manual.

The UPS 15 – 20kVA @ 220 / 230 / 240 Vac is designed for use with a five-wire input (L1,L2,L3,N,G) (3/1) .



WARNING

The battery can present a risk of electrical shock and high short circuit current. Following precautions should be observed before replacing the battery.

- Wear rubber gloves and boots.
- Remove rings, watches and other metal objects.
- Use tools with insulated handles.
- Do not lay tools or other metal objects on the batteries.
- If the battery is damaged in any way or shows signs of leakage, contact your local representative immediately.
- Do not dispose of batteries in a fire. The batteries may explode.
- Handle, transport and recycle batteries in accordance with local representative.



WARNING

Although the UPS has been designed and manufactured to ensure personal safety, improper use can result in electrical shock or fire. To ensure safety, observe the following precautions:

- Turn off and unplug the UPS before cleaning it.
- Clean the UPS with a dry cloth. Do not use liquid or aerosol cleaners.
- Never block or insert any objects into the ventilation holes or other openings of the UPS.
- Do not place the UPS power cord where it might be damaged

1 Product Description

Congratulations on your choice of the UPS uninterruptible power system (UPS), the UPS comes in nominal power ratings of 15-20kVA. It is designed to provide conditioned power to computers and other sensitive electronic equipment.

This chapter gives a brief description of the UPS, including the UPS features, models, appearance, operating principle and specification.

1.1 Electromagnetic Compatibility

* Safety	
IEC/EN 62040-1-1	
* EMI	
Conducted Emission.....IEC/EN 62040-2	Category C3
Radiated Emission.....IEC/EN 62040-2	Category C3
*EMS	
ESD.....IEC/EN 61000-4-2	Level 4
RS.....IEC/EN 61000-4-3	Level 3
EFT.....IEC/EN 61000-4-4	Level 4
SURGE.....IEC/EN 61000-4-5	Level 4
Low Frequency Signals.....IEC/EN 61000-2-2	
Warning: This is a product for commercial and industrial application in the second environment-installation restrictions or additional measures may be needed to prevent disturbances.	

NOTICE:

This is a product for restricted sales distribution to informed partners. Installation restrictions or additional measures may be needed to prevent radio interference.

Operated the UPS in an indoor environment only in an ambient temperature range of 0-40°C(32-104°F). Install it in a clean environment, free from moisture, flammable liquids, gases and corrosive substance.

This UPS contains no user-serviceable parts except the internal battery pack. The UPS “” push buttons do not electrically isolate internal parts. Under no circumstance attempt to gain access internally, due to the risk of electric shock or burn.

Do not continue to use the UPS if the panel indications are not in accordance with these operating instructions or the UPS performance alters in use. Refer all faults to your dealer.

Servicing of batteries should be performed or supervised by personnel knowledgeable of batteries and the precautions. Keep unauthorized personnel away from the batteries. Proper disposal of batteries is required. Refer to your local laws and regulations for disposal requirement.

DO NOT CONNECT equipment that could overload the UPS or demand surge current from the UPS, for example: electric drills, vacuum cleaners, hair dryer, motors and so on.

DO NOT CONNECT equipment that is life related, for example: medical equipment, elevator

and so on.

Storing magnetic media on top of the UPS may result in data loss or corruption.

Turn off and isolate the UPS before cleaning it. Use only a soft cloth, never liquid or aerosol cleaners.

1.2 Features

The UPS features include:

- ✧ Providing more high efficient AC power, compared with the previous generation
- ✧ Full digital control technology based on DSP to achieve high reliability and power function
- ✧ Fan speed can be auto conditioned according to the loads, input voltage or working mode
- ✧ Digitally controlled charger current and voltage, compared with the previous generation which is fixed in hardware
- ✧ Super high power density

1.3 Models

Available models are shown as Table 1-1:

Table 1- 1: Models

Model	Nominal Power	Type
15kVA	15 kVA /15kW	long backup model
20kVA	20 kVA / 20 kW	

1.4 Appearance

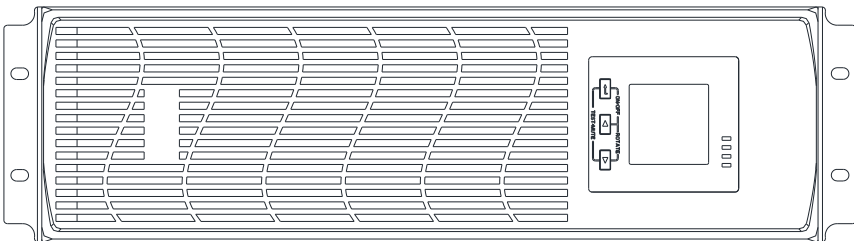

Fig 1- 1: Front View

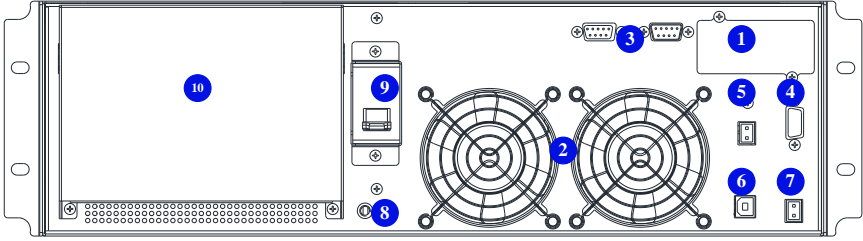

Fig 1- 2: Rear View

As shown in Fig 1-2, the rear panel provides the following components and function:

- ① SNMP: DB9 type, used to connect monitoring software
- ② Fans: intelligent fan speed control
- ③ Parallel port: option
- ④ RS232: DB9 type, used to connect monitoring software
- ⑤ EPO: NO
- ⑥ USB: B type, used to connect monitoring software
- ⑦ Temperature option
- ⑧ GND
- ⑨ Bypass breaker: surge protection
- ⑩ Terminal and cover

1.5 System Description

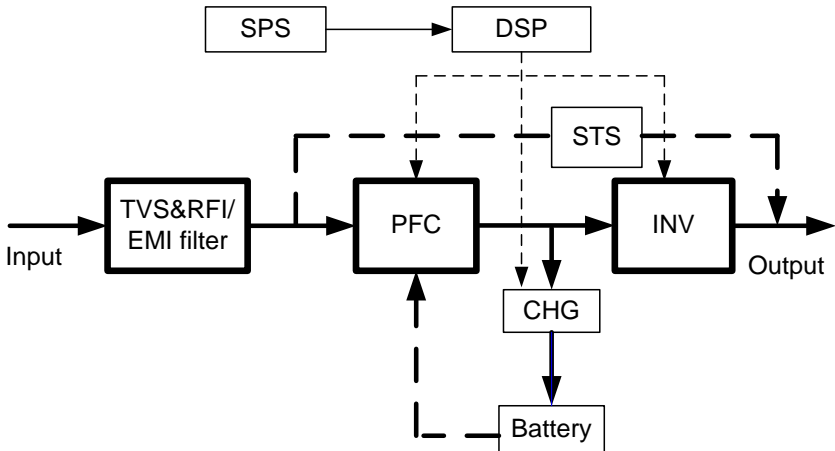

Fig 1- 3: UPS system

1.5.1 Transient Voltage Surge Suppression (TVSS) and EMI/FRI Filters

These UPS components provide surge protection and filter both electromagnetic interference (EMI) and radio frequency interference (RFI). They minimize any surge or interference present in the utility line and keep the sensitive equipment protected.

1.5.2 Rectifier/Power Factor Correction (PFC) Circuit

In normal operation, the rectifier/power factor correction (PFC) circuit converts utility AC power to regulated DC power for use by the inverter while ensuring that the waveform of the input current used by the UPS is near ideal. Extracting this sine wave input current achieves two objects:

- ✧ The utility power is used as efficiency as possible by the UPS.
- ✧ The amount of distortion reflected on the utility is reduced.

This results in cleaner power being available to other devices in the building not being protected by the UPS.

1.5.3 Inverter

In normal operation, the inverter utilizes the DC output of the power factor correction circuit and inverts it into precise, regulated sine wave AC power. Upon a utility power failure, the inverter receives its required energy from the battery through the DC-to-DC converter. In both modes of operation, the UPS inverter is on-line and continuously generating clean, precise, regulated AC output power.

1.5.4 Battery Charger

The battery charger utilizes energy from the DC bus and precisely regulates it to continuously charge the batteries. The batteries are being charged whenever the UPS is connected to utility power.

1.5.5 DC to DC Converter

The DC to DC converter utilizes energy from the battery system and raises the DC voltage to the optimum operating voltage for the inverter. The converter includes boost circuit which is also used as PFC.

1.5.6 Battery

The 6KS/10KS Standard includes value regulated, sealed lead acid, maintenance free batteries inside. To maintain battery design life, operate the UPS in an ambient temperature of 15-25°C.

1.5.7 Static Bypass

The UPS provides an alternate path for utility power to the connected load in the unlikely event of a UPS malfunction. Should the UPS have an overload, over temperature or any other failure condition, the UPS automatically transfers the connected load to bypass. Bypass operation is indicated by an audible alarm and illuminated amber Bypass LED. To manually transfer the

connected load from the inverter to bypass, press the “ ◀ + ▶ ” button once.

NOTICE: The bypass power path does NOT protect the connected equipment from disturbances in the utility supply.

1.6 UPS Working Mode

Normally UPS working mode include normal mode, bypass mode, battery mode, ECO mode, frequency converter mode, self aging mode.

Normal Mode

Shown as Fig 1-4, rectifier supply DC supply to inverter, the load is feed by inverter. Charger is charging the battery.

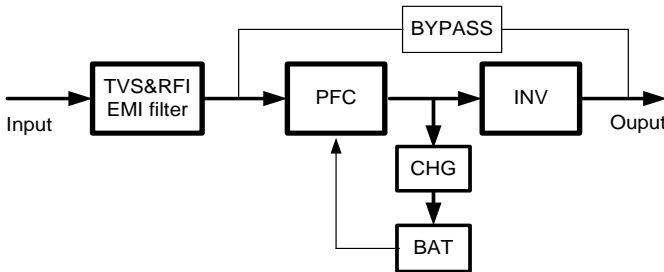

Fig 1- 4: Normal Mode

Static Bypass Mode

If inverter is failure or overload, UPS will transfer to bypass mode. Or press“ ◀ + ▶ ”to transfer to bypass mode in normal mode. The load is feed by input power directly, and UPS can not protect load from surge. Shown as Fig 1-5.

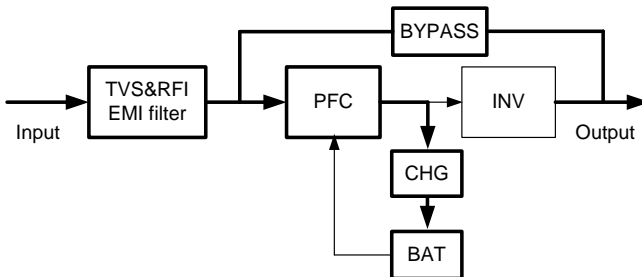

Fig 1- 5: Bypss Mode

Battery Mode

If input power is failure when in normal mode, UPS will transfer to battery mode. In this mode,

the battery provide power to inverter. Shown as Fig 1-6.

NOTICE: press“ ◀ + ▶ ”in battery mode will shutdown UPS completely.

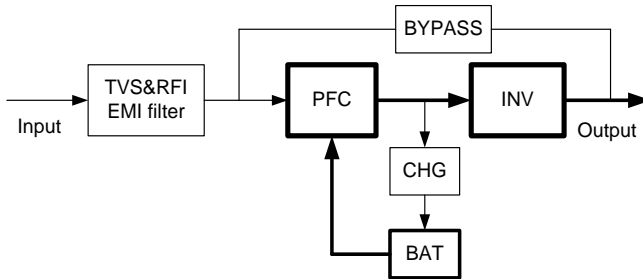

Fig 1- 6: Battery Mode

ECO Mode (only available for single unit)

When UPS works in ECO mode, load is feed by bypass. Inverter is standby, charger is working normally. The efficiency is up to 98%, but UPS can protect the load from surge disturb. If input power is failure, UPS transfer to battery mode. Shown as Fig 1-7.

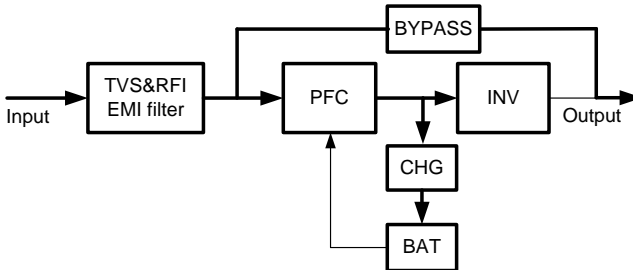

Fig 1- 7: ECO Mode

Frequency Converter Mode

In this mode, input and output nominal frequency is different, and the bypass is forbidden to use.

NOTICE: if overload timeout, UPS will shutdown output.

NOTICE: the load should be derated to 50% and below.

Self Aging Mode

If users want to burn in UPS without load, could set the UPS as Self Aging Mode, in this mode, the current flow through rectifier, inverter, and back to input through bypass. It needs only 5% loss to burn in UPS with 100% load. Shown as Fig 1-8.

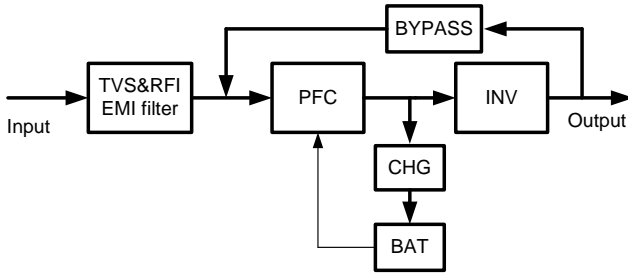

Fig 1- 8: Self Aging Mode

1.7 Product Specifications

1. General Specifications

Model		15kVA	20kVA
Power Rating		PF=1, kVA=kW	
Frequency (Hz)		50 / 60	
Input	Voltage	L-L(304-478) Vac	
	Current	Max. 30A	Max. 40 A
Battery	Voltage	192 Vdc	
	Current	Max. 100 A	Max. 134 A
Output	Voltage	220(default) / 230 / 240Vac	
	Current	68 A	91A
Efficiency		Max. 95%	
Dimension (W x D x H) (mm)		440 * 132 *780	
Weight (kg)		25.5	

2. Electrical Performance

Input			
Model	Voltage	Frequency	Power Factor
UPS	Single-phase	40 - 70 Hz	> 0.99 (Full load)

Output					
Voltage Regulation	Power Factor	Frequency tolerance.	Distortion	Overload capacity	Crest ratio
±1%	1	±0.1 of normal	THD < 1% Full load (Linear Load)	<ul style="list-style-type: none"> ➤ 110% load: transfers to Bypass mode after 60 minutes ➤ 125% load: transfers to Bypass mode after 1 minute ➤ 150% load: transfers to Bypass mode after 0.5 minute and shutdown the output after 1 minute 	3:1 maximum

3. Operating Environment

Temperature	Humidity	Altitude	Storage temperature
0°C - 40°C	< 95%	< 1000 m	0°C - 70°C

NOTICE: If the UPS is installed or used in a place where the altitude is above than **1000 m**, the output power must be derated in use, please refer to the following:

Altitude (M)	1000	1500	2000	2500	3000	3500	4000	4500	5000
Derating Power	100%	95%	91%	86%	82%	78%	74%	70%	67%

2 Installation

The system should be installed and wired only by qualified electricians in accordance with applicable safety regulations.

NOTICE: UPS operation in sustained temperature outside the range of 15 - 25°C (59 - 77°F) reduces battery life.

2.1 Unpacking and Inspection

1. Unpack the packaging and check the package contents. The shipping package contains:
 - 1 UPS
 - 1 user manual
2. Inspect the appearance of the UPS to see if there is any damage during transportation. Do not turn on the unit and notify the carrier and dealer immediately if there is any damage or lacking of some parts.

2.2 Main cabinet installation

Two installation modes are available: tower installation and rack installation, depending on available space and user considerations. You can select an appropriate installation mode according to the actual conditions

1. Notes for installation

- (1) The UPS must be installed in a location with good ventilation, far away from water, inflammable gas and corrosive agents.
- (2) Ensure the air vents on the front and rear of the UPS are not blocked. Allow at least 0.5 m of space on each side.
- (3) Condensation to water drops may occur if the UPS is unpacked in a very low temperature environment. In this case it is necessary to wait until the UPS is fully dried inside out before proceeding installation and use. Otherwise there are hazards of electric shock.
- (4) The circuit breaker (CB) with residual current device (RCD) should not be used in the input of UPS.

2. Tower Installation

Various installation configurations are available: single UPS, single UPS with single or multiple battery cabinets. Their installation methods are all the same.

The installation procedures are as follows:

Step 1: Take out the support bases from the accessories. Their appearances are shown in Fig.2-

1.

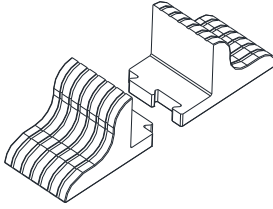

Fig.2-1 Support bases

Step 2: If optional external battery cabinets are connected to the UPS to provide additional battery run time, assemble the spacers and the support bases, as shown in Fig.2-2.

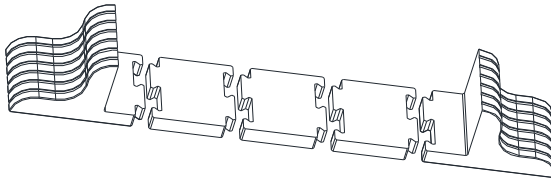

Fig.2-2 Installing support bases with spacers

Step 4: Place the UPS (and battery cabinet) on the support bases. Each UPS needs two pairs of support bases to install, as shown in Fig.2-3.

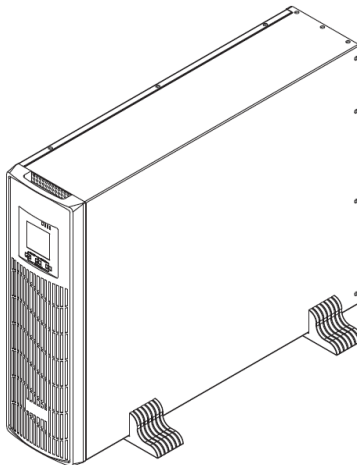

Fig.2-3 Tower installation

2. Rack Installation

1. Various installation configurations are available: single UPS, single UPS with single or multiple-battery. Their installation methods are all the same.
2. Because battery cabinets are too heavy, they must be installed first, and two or more installation personnel are required to install them at the same time. Please install them from bottom to top.

Rack installation: fix the UPS and battery cabinet onto the rack through brackets.

Installation method:

1. Take out two brackets and M4 × 10 screws from the accessories, and fix the brackets onto the UPS using the screws through installation hole, as shown in Fig.2-4.

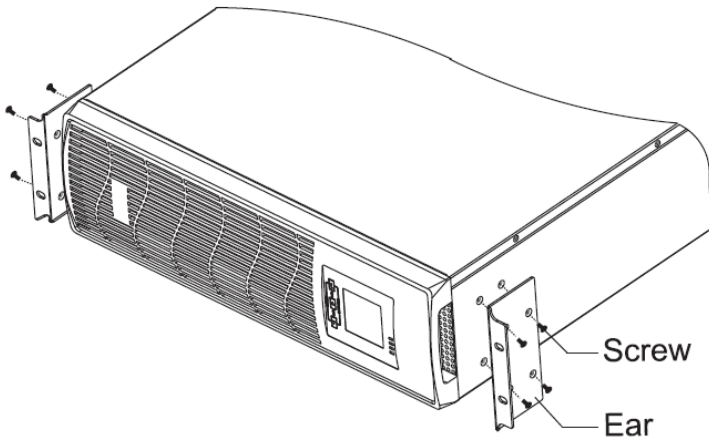

Fig.2-4

Installing brackets

2. Place the UPS onto the guide rail in the rack, and push it completely into the rack along the guide rail (it is prohibited to move the UPS through the brackets). And fix the UPS onto the rack using the screws through installation hole on the bracket, as shown in Fig.2-5.

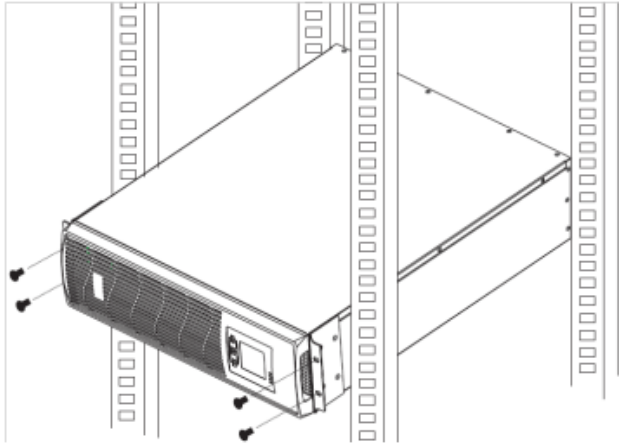

Fig.2-5 Installing UPS

2.3 Connect Input/Output Power

1. Notes for installation

- (1) The UPS must be installed in a location with good ventilation, far away from water, inflammable gas and corrosive agents.
- (2) Ensure the air vents on the front and rear of the UPS are not blocked. Allow at least 0.5 m of space on each side.
- (3) Condensation to water drops may occur if the UPS is unpacked in a very low temperature environment. In this case it is necessary to wait until the UPS is fully dried inside out before proceeding installation and use. Otherwise there are hazards of electric shock.
- (4) The circuit breaker (CB) with residual current device (RCD) should not be used in the input of UPS.

2. Installation

Installation and wiring must be performed in accordance with the local electric code and the following instructions by professional personnel.

For safety, please cut off the mains power switch before installation. Open the battery breaker for long backup time model ("H" model).

- (1) Open the terminal block cover located on the rear panel of the UPS, please refer to the appearance diagram.
- (2) For 15kVA UPS, it is recommended to select the UL1015 6 AWG (16 mm²) wire or other insulated wire which complies with AWG Standard for the UPS input and output wirings.
- (3) For 20kVA UPS, it is recommended to select the UL1015 4 AWG (25 mm²) wire or other insulated wire which complies with AWG Standard for the UPS input and output wirings.

NOTICE: Do not use the wall receptacle as the input power source for the UPS, as its rated

current is less than the UPS's maximum input current. Otherwise the receptacle may be burned and destroyed. For the long backup time modes, make sure that the capacity of batteries is larger than 24 Ah to avoid over charging. If not, please confirm the charge current and set the charge current according to battery capacity.

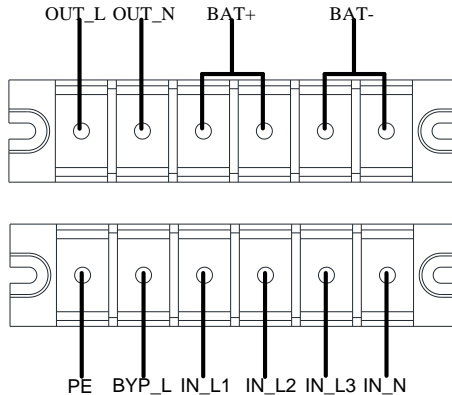

Fig 2- 6: Terminal Block Wiring Diagram

NOTICE: Make sure that the input and output wires and the input and output terminals are connected tightly.

- (4) Connect the input, output and battery wires to the terminals as Fig 2-6.
- (5) The protective earth ground wire refers to the wire connection between the equipment which consumes electric equipment and the ground wire. The wire diameter of protective earth ground wire should be at least as above mentioned for each model and green wire or green wire with yellow ribbon wire is used.
- (6) After having completed the installation, make sure the wiring connection is correct.
- (7) Please install the output breaker between the output terminal and the load.
- (8) To connect the load with the UPS, please turn off all the loads first, then perform the connection and finally turn on the loads one by one.
- (9) No matter the UPS is connected to the utility power or not, the output of the UPS may have electricity. The parts inside the unit may still have hazardous voltage after turning off the UPS. To make the UPS have no output, power off the UPS, and then disconnect the utility power supply.
- (10) Suggest charging the batteries for 8 hours before use. After connection, turn the input breaker in the "ON" position, the UPS will charge the batteries automatically. You can also use the UPS immediately without charging the batteries first, but the backup time may be less than the standard value.
- (11) If it is necessary to connect the inductive load such as a motor or a laser printer to the UPS, the start-up power should be used for calculating the capacity of the UPS, as its start-up power consumption is too big when it is started.

2.4 Connect the Long Backup Time Model UPS with the External Battery

1. The nominal DC voltage of external battery pack is 192 Vdc. Each battery pack consists of 16 pieces of 12 V maintenance free batteries in series. To achieve longer backup time, it is possible to connect multi-battery packs, but the principle of “same voltage, same type” should be strictly followed.
2. For UPS 15/20KH, select the UL1015 6/4 AWG (16/25 mm²) or other insulated wire which complies with UL Standard for the UPS battery wirings. The procedure of installing battery bank should be complied with strictly. Otherwise you may encounter the hazardous of electric shock.
 - (1) A DC breaker must be connected between the battery pack and the UPS. The capacity of breaker must be not less than the data specified in the general specification.
 - (2) Set the battery pack breaker in “**OFF**” position and connect the 16 pieces of batteries in series.
 - (3) You must connect the external battery cable to the battery first, if you connect the cable to the UPS first, you may encounter the hazardous of electric shock. The positive pole of the battery is connected to the UPS with red wire; the negative pole of the battery is connected to the UPS with black wire; the green and yellow ribbon wire is connected to the ground of the battery cabinet.
3. To complete the connection of the external battery cable into the UPS. Do not attempt to connect any loads to the UPS now. You should connect the input power wire to the right position first. And then set breaker of the battery pack in the “**ON**” position. After that set the input breaker in the “**ON**” position, the UPS begins to charge the battery packs at the time.

2.5 Connect Parallel Cables

1. Brief introduction

As long as the UPS is equipped with parallel cables, up to 4 UPS can be connected in parallel to realize output power sharing and power redundancy. The unit ID in paralleled system must be set to be different.

2. Parallel installation

- (1) Users need to opt two standard 15-pin communication cables which length is appropriate to be less than 3 m.
- (2) Strictly follow the stand-alone wiring requirement to perform the input wiring of each UPS.
- (3) Connect the output wires of each UPS to an output breaker panel.
- (4) Each UPS needs an independent battery pack.
- (5) Please refer to the wiring diagram in the next page, and opt suitable breaker.

The requirement of the output wiring is as follows:

 - It's recommended that the wires of output of the UPS to be less than 20 m.
 - The difference between the wires of input & output of the UPS is required to be less than 10%.

The wiring diagram is shown as follows:

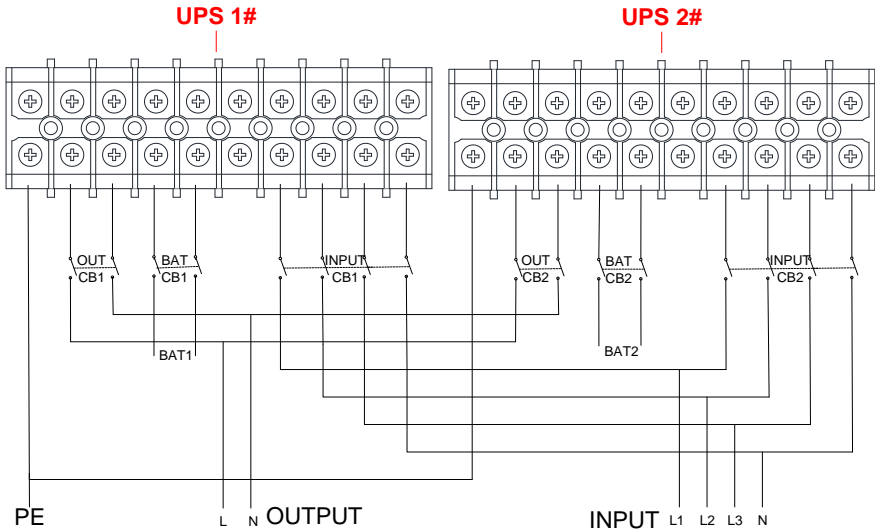

Fig 2- 7: Parallel Wiring Diagram

2.6 Connect Communication Cables

Connect communication cables:

If there are 2 UPS are paralleled, connect communication cables as Fig 2-8.

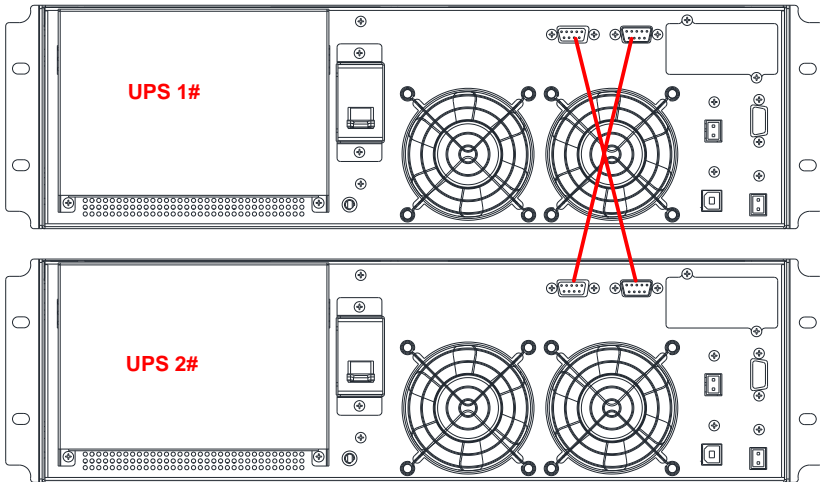

Fig 2- 8: 2 UPS Paralleled System

If there are 3 UPS are paralleled, connect communication cables as Fig 2-9.

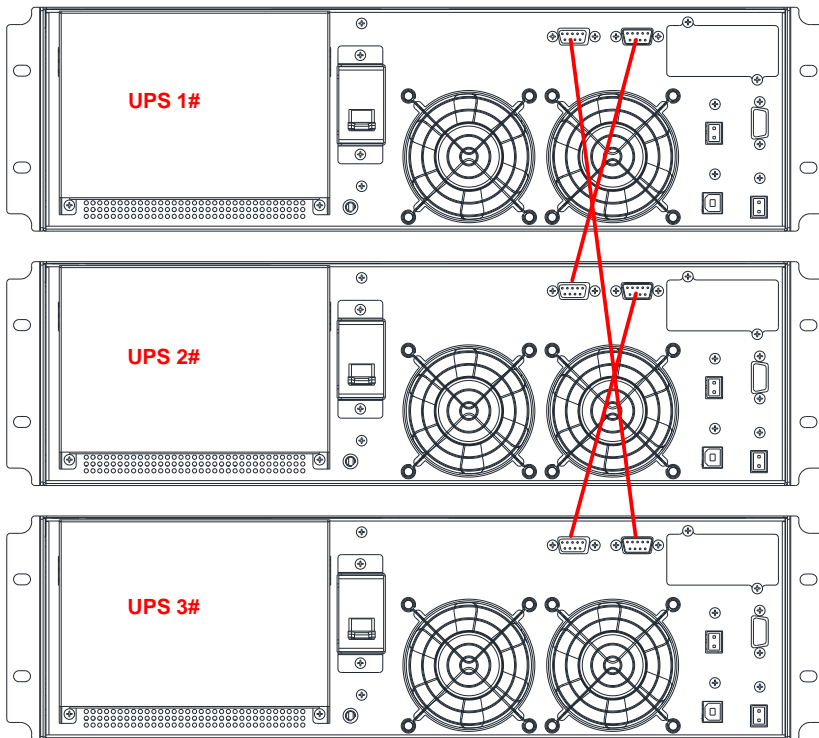

Fig 2- 9: 3 UPS Paralleled System

|
NOTICE: must set the UPS is parallel system as “parallel work mode” via software according to “Annex A” before start parallel system

3 Control and Indicators

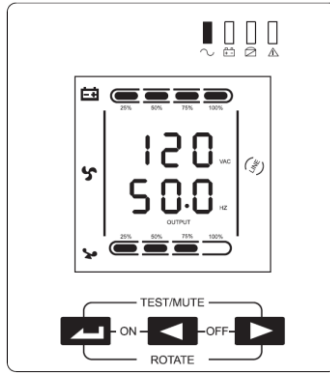























Fig 3- 1: Display Panel

Description of Panel

Controls	Description
	<ol style="list-style-type: none"> 1. Press “” to power on the UPS from battery without utility power. <p>NOTE Not available when UPS is set in automatically start mode</p> <ol style="list-style-type: none"> 2. Press “ + ” to start inverter when rectifier is OK 3. Press “ + ” to start the ups from battery without utility 4. Press “” to confirm setting when in setting mode 5. Press and hold “”to enter or exit the setting mode 6. Press and hold “ + ” to enter the self-test mode when ups is normal, otherwise to mute off the alarm, press and hold again to mute on. 7. Press “” to rotate the display interface 90 degrees in normal mode without warning and fault.
	<ol style="list-style-type: none"> 1. Press “” to page up the LCD menu 2. Press and hold “” to enter the history inquiry interface 3. Press “ + ” to shutdown inverter and transfer to bypass 4. Press “ + ” to shutdown UPS completely when UPS is in battery mode
	<ol style="list-style-type: none"> 1. Press “” to page down the LCD menu 2. Press and hold “” to fault clear 3. Press and hold “” to select rotating LCD without warning and fault for 15-20kVA rack UPS

Indicators	Description
1. INV	Inverter indicator: green--inverter is normal, green flicker—rectifier or inverter is starting or tracking with bypass(ECO), dark—rectifier and inverter is not working
2. BAT	Battery indicator: yellow—battery discharged, yellow flicker—No battery or battery alarm, dark—battery is connected
3. BYP	Bypass indicator: yellow—bypass is normal, yellow flicker—bypass is abnormal and alarm ,dark—UPS is in normal mode and bypass is normal
4. FAULT	FAULT indicator: red—UPS is abnormal, red flicker—UPS alarm ,dark—UPS is normal

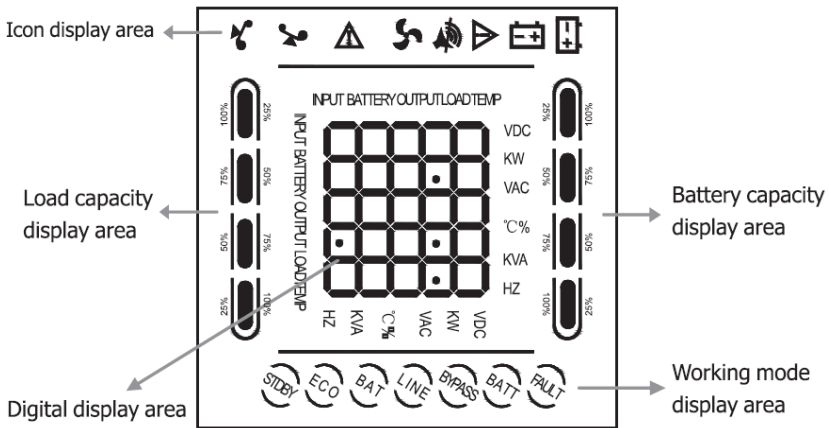

Fig 3- 2: LCD Menu

LCD display is divided into three areas: Icons display area, value display and settings area, and operation mode area.

❖ Icons display area:

◆ There are following contents in the area of display page

- Load and battery icons indicate load and battery capacity, and each square represents 25% of capacity. Load icon will flash when UPS is overloaded; battery icon will flash when battery capacity is too low or the battery is not connected.
- Fan icon indicates the working status of fans. Normally, the fan shows rotation status. The icon will flash if fans are disconnected or faulty;
- Buzzer icon indicates if the buzzer is mute. Normally, this icon doesn't display. Press and hold the " ← + → " buttons in battery or fault mode or set monitoring software to set MUTE ON in any mode, the UPS will get into mute status and the buzzer icon

will be illuminated.

➤ Fault icon is illuminated in fault mode, it doesn't display in other cases.

◆ The area of menu setting page showing the setttable menu options

◆ The area of event log query page showing page number of history records

❖ Value display and settings area:

➤ In non-setting interface, it indicates the relevant information of UPS. Press the “ ◀ ” or “ ▶ ” button to display input voltage and frequency, output voltage and frequency, battery voltage and capacity, pieces of battery, load, temperature, software version, etc.



➤ The fault code will be displayed in fault mode.





➤ In menu setting interface, include output voltage value (OPU), physical address(Id), parallel Enable (PAL), end of discharge point (Eod), Expert mode (EP), Battery numbers(PCS),Emergency power off (EPO),etc.



❖ Operation mode area:

➤ This display area mainly indicates the UPS operation mode in 20 seconds after starting up, such as stdby (Standby mode), bypass (Bypass mode), line (Utility mode), bat (Battery mode), batt (Battery self test mode), fault (Fault mode),cucf(Frequency conversion mode), ECO (economy mode).

Description of LCD Menu

Page	Description
	<p>Page 1 (output interface): Display UPS output information</p>
	<p>Page 2: Display UPS bypass information</p>

 <p>The display shows 'LOAD' information. The top row shows '1.9 KW' and the bottom row shows '1.9 KVA'. On the left and right sides, there are vertical progress bars for load percentage, ranging from 25% to 100%. At the bottom, there is a 'LINE' indicator.</p>	<p>Page3: Display UPS load information</p>
 <p>The display shows 'TEMP' information. The top row shows '02.2' and the bottom row shows '3.1 °C'. On the left and right sides, there are vertical progress bars for temperature percentage, ranging from 25% to 100%. At the bottom, there is a 'LINE' indicator.</p>	<p>Page 4: Display UPS software version and temperature information</p>
 <p>The display shows 'INPUT' information. The top row shows '234 VAC' and the bottom row shows '49.9 HZ'. On the left and right sides, there are vertical progress bars for input percentage, ranging from 25% to 100%. At the bottom, there is a 'LINE' indicator.</p>	<p>Page 5: Display UPS input information</p>
 <p>The display shows 'BATTERY' information. The top row shows '215 VDC' and the bottom row shows '95 %'. On the left and right sides, there are vertical progress bars for battery percentage, ranging from 25% to 100%. At the bottom, there is a 'LINE' indicator.</p>	<p>Page 6: Display UPS battery voltage, battery capacity percentage</p>













	<p>Page 7: Display UPS battery numbers,</p>
	<p>Warning code Page: Display UPS warning code (ALA means alarm) All warning code information refer to “troubleshooting”.</p>
	<p>◇ History event query H - history, H01 - ninth history event. 063 - history event code. History event query is for qualified personnel use only.</p>



◇ History event query



Press and hold the “◀” button to enter Event log query interface; Press inquiry button “◀” or “▶” to look over event logs with page turning. There are maximum 20 pages (600 pieces monitoring software) event logs records. Press and hold the “◀” button again to return to the home screen.

Parameters setting

If want to set rated parameters, Press and hold “” in setting mode, the settable menu will flick.

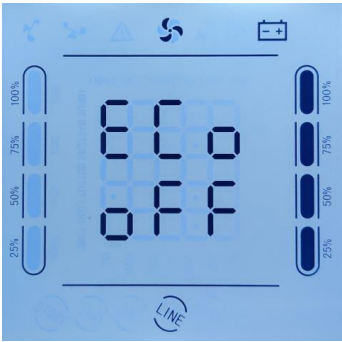
<p>Charger current setting</p>	<p>Charger current could be set as follow, Press “” or “” to select, press “” to confirm selection</p> <p>Standard model:1A Long backup model : 1,2,3,4,5A Optional charger 12A for 6-10KVA:1-12A Optional charger 10A for 15-20KVA: 1-10A</p>	
<p>Parallel ID setting</p>	<p>1- parallel Id 1 In parallel mode, the parallel ID could be set as 1 to 19 press “” or “” to select, press “” to confirm selection</p>	
<p>Parallel mode setting</p>	<p>Could select ON: parallel mode OFF: single mode press “” or “” to select, press “” to confirm selection</p>	

<p>EP mode setting</p>	<p>Could select ON: enable, you can select EPO,ECO , Rated frequency, Battery number setting, Charger current setting OFF: disable (default doesn't work) Press “ ◀ ” or “ ▶ ” to select, press “ ↵ ” to confirm selection</p>	
<p>Rated voltage setting</p>	<p>Could select rated voltage as 208 Vac / 220 Vac / 230 Vac / 240 Vac, press “ ◀ ” or “ ▶ ” to select, press “ ↵ ” to confirm selection. The setting will be activated after restart UPS.</p>	
<p>ECO mode setting</p>	<p>Could select ON: enable OFF: disable press “ ◀ ” or “ ▶ ” to select, press “ ↵ ” to confirm selection</p>	

<p>EPO setting</p>	<p>Could select ON: enable OFF: disable (default doesn't work) Press “◀” or “▶” to select, press “↵” to confirm selection</p>	 <p>The screenshot shows the main menu of the UPS LCD. At the top, there are icons for navigation and a battery status indicator. The central display shows 'EPO' in large digits, with 'on' selected below it. The background features a grid of settings, and there are two vertical progress bars on either side, each with markers at 25%, 50%, 75%, and 100%. A 'LINE' indicator is visible at the bottom.</p>
<p>Battery number setting</p>	<p>Could select battery number as 16 blocks (192 Vdc) 18 blocks (216 Vdc) 20 blocks (240 Vdc) press “◀” or “▶” to select, press “↵” to confirm selection. The setting will be activated after restart UPS.</p>	 <p>The screenshot shows the main menu of the UPS LCD. The central display shows 'BOS' in large digits, with '16' selected below it. The background features a grid of settings, and there are two vertical progress bars on either side, each with markers at 25%, 50%, 75%, and 100%. A 'LINE' indicator is visible at the bottom.</p>
<p>Rated frequency setting</p>	<p>Could select rated frequency as 50 Hz / 60 Hz, press “◀” or “▶” to select, press “↵” to confirm selection. The setting will be activated after restart UPS.</p>	 <p>The screenshot shows the main menu of the UPS LCD. The central display shows 'FC' in large digits, with '50.0 HZ' selected below it. The background features a grid of settings, and there are two vertical progress bars on either side, each with markers at 25%, 50%, 75%, and 100%. A 'LINE' indicator is visible at the bottom.</p>



NOTICE: when rated voltage is 200 / 208 Vac, the output PF is 0.9. If other parameters are needed to change, please set it via monitoring software.

4 Operation

4.1 Operation Mode



4.1.1 Turn on the UPS in Normal Mode

- (1) After you make sure that the power supply connection is correct, and then close the battery breaker (this step only for long backup time model), after that close the main input and bypass input breaker. At this time the fans rotate and the UPS operates in Bypass mode.
- (2) After inverter LED start to flick, the BYPASS starts and bypass LED is yellow, now the output load is feed by bypass.



NOTE: In some application, UPS is set to start manually, you should press “ +  ” to start inverter.

- (3) The inverter LED is green, the UPS turn into normal working mode. If the utility power is abnormal, the UPS will operate in Battery mode without output interruption of the UPS.



4.1.2 Turn on the UPS from Battery without Utility Power

- (1) After you make sure that the breaker of the battery pack is in the “ON” position (this step only for long backup time model).
- (2) Press “ ” button once to power on the UPS. Press “ +  ” for 2 s once buzzer is on.
- (3) About 1 minute later, the UPS turns into Battery mode. If utility power recovers, UPS will transfer to normal mode.

4.1.3 Turn off the UPS in Normal Mode

- (1) Shutdown the connected load and open external output breaker
- (2) Press “ +  ” button in condition of normal mode to transfer to bypass.
- (3) For long backup model, open the mains input breaker and bypass input breaker, then open the battery breaker to turn off UPS completely.
- (4) For standard model, open mains input and bypass input breaker, the UPS will shut down completely after a few seconds.

4.1.4 Turn off the UPS in Battery Mode

- (1) To power off the UPS by pressing the “ +  ” button for more than 1 second.
- (2) When being powered off, the UPS will turn into No Output mode. Finally not any display is shown on the display panel and no voltage is available from the UPS output.

NOTICE: Please turn off the connected loads before turning on the UPS and turn on the loads one by one after the UPS is working in INV mode. Turn off all of the connected loads before turning off the UPS.



WARNING: Internal DC bus still has hazardous high voltage in several minutes, please wait for at least 10 minutes to open UPS. And check the DC bus voltage before maintenance.

4.2 Parallel Operation

4.2.1 Turn on the UPS of Parallel System

Make sure the power cables and communication cables are correctly. Shown as Fig 2-7, Fig 2-8, Fig 2-9:

- (1) Close external output CB1 and CB2.
- (2) Close mains input breakers and bypass input breakers of UPS1 and UPS2, after about 2 minutes, UPS work in parallel mode.
- (3) Close external battery breakers.
- (4) Turn on load. The load is now powered by parallel system.

4.2.2 Turn off Parallel System

- (1) Turn off the connected load. Press the “ ◀ + ▶ ” button to transfer to bypass. Open output breakers. Open mains input and bypass input breakers of all UPS.
- (2) If is long backup model, open external battery breakers. After a few seconds, the UPS will shut down completely.

4.2.3 How to install a new parallel UPS system

- (1) Before installing a new parallel UPS system, user need to prepare the input and output wires, the output breaker, and the parallel cables.
- (2) Open the input and output breakers of each UPS. Connect the input wires, output wires and battery wires.
- (3) Connect each UPS one by one with the parallel cables.
- (4) Close the battery breakers and the input breakers of all of the UPS in the parallel system in turn.
- (5) Turn on each UPS in turn and observe their display. Make sure that each UPS displays normal and all the UPS transfer to the INV mode normally.

4.2.4 How to remove a single UPS from the parallel system

- (1) If you need to remove one UPS of the UPS parallel system which is in normal mode, press the “ ◀ + ▶ ” button of the UPS that is confirmed to be removed and the UPS will cut off its output immediately.
- (2) Turn off mains input breaker, bypass input breaker, the external mains input breaker, the output breaker and the battery breaker.
- (3) Press the others UPS's “ ◀ + ▶ ” button. All of them transfer to the Bypass mode.
- (4) Remove the parallel cables of the UPS that need to be removed.
- (5) Press “ ⏪ + ▶ ” button of remained UPS to make the UPS transfer to INV output.

5 Communication

UPS includes several communication ports: RS232, EPO, SNMP card, USB, dry contact, RS485.

NOTICE: Only one of SNMP card, dry contact and RS485 can be at the same time. Only one of RS232 and USB is available at the same time.

Connect the UPS and monitoring equipment (computer) by standard RS232 port (standard configuration) and standard USB port (optional configuration) to make single unit communication.

- Connect RS232 (or USB) cable to the serial port of the computer (or USB port)
- Connect RS232 (or USB) cable to the serial port of the UPS (or USB port)

5.1 RS232 and USB Port

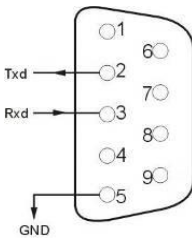

Pins	1	2	3	4	5
Definition	Empty	Transmit	Receive	Empty	GND
Pins	6	7	8	9	
Definition	Empty	Empty	Empty	Empty	

❖ USB port (optional)

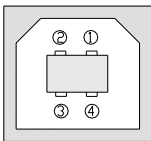

Pins	1	2	3	4
Definition	Power source + 5 V	Data+	Data -	GND

5.2 EPO Port

The Emergency Power Off (EPO) is a feature that will immediately disconnect all connected equipment from mains power. The remoted EPO is located on the rear panel of UPS with green terminals shown as Fig 1-2. It's normal opened, if it's closed, it will activate EPO function, the UPS will be shutdown.

NOTE: The system default EPO doesn't work, if you want to use this feature, need to set the monitoring software function.

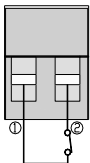

In normal condition, pins □ and pins □ are opened;

when perform Emergency Power Off, connect pins □ and pins □.

5.3 Intelligent Cards (Optional)

The UPS has one intelligent slot for SNMP card, dry contacts card and RS485 card.

Intelligent cards are installed in the intelligent slots on the UPS rear panel, and there is no need to stop the UPS during installation. The installation procedure is as follows:

- Remove the cover plate of the intelligent slots
- Insert the required intelligent card into the slot
- Tighten the screws
- ◇ SNMP card (optional)

SNMP card is used to monitor the UPS via TCP/IP, user can check the UPS status, voltage and current on the internet. Please refer to the user manual of SNMP card to get more detailed information.

- ◇ Dry contacts card (optional)

Insert dry contacts card into the intelligent slot to monitor and manage the UPS.

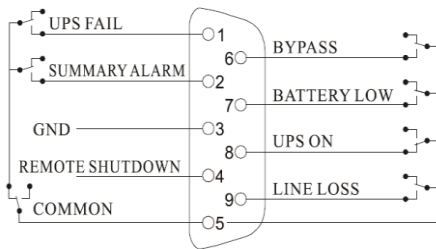

Pins	Definition
PIN1	Close : UPS fault
PIN2	Close : Alarm sounds (system fault)
PIN3	Grounding
PIN4	Remote shutdown
PIN5	Common
PIN6	Close : bypass working
PIN7	Close : low battery
PIN8	Close : UPS working Open : bypass working
PIN9	Close : Mains power Off

- ◇ RS485 card (optional)

RS485 is optional function for user to integrated monitoring and communication. RS485,SNMP and dry contact are installed in one intelligent slot A and B on the right side of ports are RS485 output, A is "+", B is "-".



6 Maintenance

This chapter includes battery maintenance, battery disposal and replacement, check UPS status and function.

6.1 Battery Maintenance

The UPS only requires minimal maintenance. The batteries used for standard models are value regulated, sealed lead-acid, maintenance free battery. When being connected to the utility power, whether the UPS is turned on or not, the UPS keeps charging the batteries and also offers the protective function of overcharging and over-discharging.

- (1) The UPS should be charged once every 4 to 6 months if it has not been used for a long time.
- (2) In the regions of hot climates, the battery should be charged and discharged every 2 months. The standard charging time should be at least 12 hours.
- (3) Under normal conditions, the battery life lasts 3 to 5 years. In case if the battery is found in bad condition, earlier replacement should be made.
- (4) Battery replacement should be performed by qualified personnel.
- (5) Replace batteries with the same number and same type of batteries.
- (6) Do not replace the battery individually. All the batteries should be replaced at the same time following the instructions of the battery supplier.

6.2 Battery Disposal

- (1) Before disposing of batteries, remove jewelry, watches and other metal objects.
- (2) Use rubber gloves and boots, use tools with insulated handles.
- (3) If it is necessary to replace any connection cables, please purchase the original materials from the authorized distributors or service centers, so as to avoid overheat or spark resulting in fire due to insufficient capacity.
- (4) Do not dispose of batteries or battery packs in a fire. The batteries may explode.
- (5) Do not open or mutilate batteries, released electrolyte is highly poisonous and harmful to the skin and eyes.
- (6) Do not short the positive and negative of the battery electrode, otherwise, it may result in electric shock or fire.
- (7) Make sure that there is no voltage before touching the batteries. The battery circuit is not isolated from the input potential circuit. There may be hazardous voltage between the battery terminals and the ground.
- (8) Even though the input breaker is disconnected, the components inside the UPS are still connected with the batteries, and there are potential hazardous voltages. Therefore, before any maintenance and repairs work is carried out, switch off the breaker of the battery pack or disconnect the jumper wire of connecting between the batteries.
- (9) Batteries contain hazardous voltage and current. Battery maintenance such as the battery replacement must be carried out by qualified personnel who are knowledgeable about

batteries. No other persons should handle the batteries.

6.3 Battery Replacement Procedures

- (1) Press “ ◀ + ▶ ” button to transfer to bypass mode
- (2) Close the manual bypass breaker
- (3) Remove both side covers from the UPS.
- (4) Disconnect the battery wires one by one.
- (5) Remove metal bars which are used to fasten batteries.
- (6) Replace batteries one by one.
- (7) Screw metal bars back to UPS.
- (8) Connect the battery wires one by one. Take care of electrical shock while connecting the last wire.

6.4 Precaution

Although the UPS has been designed and manufactured to ensure personal safety, improper use can result in electrical shock or fire. To ensure safety, observe the following precautions:

- (1) Turn off the UPS before cleaning it;
- (2) Clean the UPS with a dry cloth. Do not use liquid or aerosol cleaners;
- (3) Never block or insert any objects into the ventilation holes or other openings of the UPS;

6.5 Checking UPS Status

It is recommended to check the UPS once every half year.

- (1) Check if the UPS is faulty: Are the LED indicators abnormal? Is there any alarm?
- (2) Check if the UPS is working in bypass mode: Normally, the UPS works in normal mode, if it's working in bypass mode, please check: overload, internal fault and so on.
- (3) Check if the battery is discharging: When the mains input is normal, the battery should not discharge, if the UPS is working in battery mode, please check: if mains input is failure, battery test, operator intervention and so on.

7 Troubleshooting

This chapter describes checking the UPS's status. This section also indicates various UPS symptoms a user may encounter and provides a troubleshooting guide in the event the UPS develops a problem. Use the following information to determine whether external factors caused the problem and how to remedy the situation.

If UPS alarms and buzzer sound, please press “▶” to get alarm code on the menu of alarm code on LCD. And press and hold “▶” to manually fault clear. If alarms is still existent, please check the problem follow the Table 7-1:

LCD display in fault mode is shown as below:



Fig 7- 1: Fault code

Fault code informing:

Fault Code	Cause	Solution
35 - 39	Inverter forbidden	/
40 - 44	over temperature	Rectifier heat sink is over temperature or the temp sensor is not connected correctly. Check if fans are working normally Check if anything block ventilation Check if the sensor is connected correctly Check if the environmental temp is over the range of UPS
45 - 49	Output shorted	Load is abnormal or output breaker is shorted. Check if load is abnormal and the faulty load is shutdown Check if output breaker is faulty If the faulty load is removed, please manually fault clear to restart UPS.

50 - 54	Overload	Inverter is overload, please remove numbers of non-critical loads, or else UPS could transfer to bypass If bypass overload, Check the load and remove some non-critical load until the load is below 95%
55 - 59	Negative power fault	Please contact your supplier.
85 - 89	Bus short	Please contact your supplier.
120 - 124	Inverter fault	Inverter voltage is abnormal, or inverter IGBT opened. Please manually clear the fault and if the fault is still on, please contact with local dealer
130 - 134	Inverter relay opened	Inverter relay is opened. Please contact with local dealer
135 - 139	Rectifier fault	DC bus over voltage, low voltage, shorted or IGBT opened. Please manually clear the fault and if the fault is still on, please contact with local dealer
145 - 149	Fan fault	One or more fans are faulty or blocked Check if all fans working normally Check if something blocks fan
150 - 154	EPO	Check if EPO is closed correctly Check if EPO is activated manually
155 - 159	SPS abnormal	Please contact your supplier.

Note:

Contact the supplier if display screen shows other fault information. After trouble shooting, please manually fault clear to restart UPS.



Fig 7- 2: Warning code

Warning code informing:

Warning code	Warning name	Solutions
200	Parallel cables error	Check if all parallel communication cables are connected correctly
202	Battery reversed	Check if battery cables are connected correctly Check if inverter cables of battery packs are connected correctly
203	Overload	Remove non-critical devices to reduce the loads connected to UPS.
204	No battery	Check if the battery cables are connected correctly Check battery breaker or fuses are opened Check if batteries are damaged
205	Input over current	Check if rectifier IGBT is broken, DC bus is shorted, or IGBT drivers are lost, input voltage display is wrong.
206	Battery overcharged	Switch off battery breaker, remove devices connected to UPS, shutdown UPS, and replace new charger.
208	Charger fail	Charger is faulty or is not disconnected. Please contact with local dealer
209	EEPROM fault	Clean the warning by LCD panel or using debug software. Or shutdown UPS and startup again.
210	Input over current time out	Check the input voltage is abnormal
211	Battery voltage low	Remove non-critical devices and charge the battery as soon as possible.
214	Synchronize signal loss	Check whether the parallel wire connecting and parallel boards are abnormal or not.
215	CAN communication fail	Check whether the parallel wire connecting and parallel boards are abnormal or not.
217	Bypass fault	Check whether bypass voltage is normal or not.
220	Over synchronization	Bypass voltage or frequency is over tracking range. There could be interruption if manually transfer to bypass or inverter is faulty
221	Over transfer times	Mains and battery or inverter and bypass transfer for 5 times in 1hour
222	End of discharge	Charge the battery as soon as possible.
223	Battery test ok	

224	Forbidden startup UPS	Check whether mains voltage and frequency is normal or not.
225	Battery test is abnormal	/
226	Parallel current unbalance	Check whether the parallel wire connecting and parallel boards are abnormal or not.
228	Battery maintenance ok	/
229	Battery maintenance is abnormal	/
230	Input current unbalance	/
233	Over transfer times	Mains and battery transfer for 5 times in 1hour,while Bus is low
234	Utility abnormal	UPS mains input is abnormal. Check if mains input is normal Check if mains input voltage and frequency is over the working range Check if mains input breaker or external input breaker is opened Check if the input phase sequence against Please recover mains input power, otherwise output will be shut down if battery is discharged to EOD
235	Bypass abnormal	Check if bypass input power is abnormal Check if bypass input breaker is opened Please recover bypass input power, otherwise there will be no backup circuit when UPS is faulty
238	Battery voltage is abnormal(reserved)	/
241	Manual bypass on	Manual bypass is closed, the UPS will transfer to bypass and forbidden to transfer back to inverter

Annex Parallel Setting

1. Connect UPS1# with RS232 cable to PC. Connect UPS with monitoring software "iServiceTool". Select "EA900P6-20K G4".

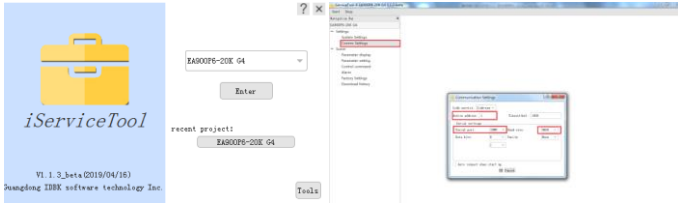

2. Enter in menu "Settings", set "device address" as "1" and "baud rate" as "9600", select the right serial port in menu "Communication Setting". Click "OK" to connect UPS
3. Enter in menu "Scene", set "System Work Mode" as "Parallel Operation", "Parallel device number" as "1", "Parallel device address" as "1" in the menu "Parameter Setting". Click "ok" to confirm setting. If there are 3 UPS are paralleled, Set "Parallel device number" as "3".

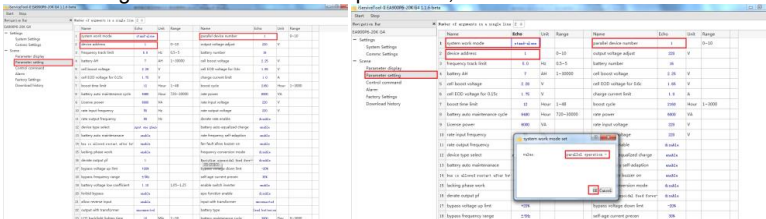

4. Connect UPS2# and set "System Work Mode" as "Parallel Operation", "Parallel device number" as "2", "Parallel device address" as "2" in the menu "Parameter Setting". Click "ok" to confirm setting. If there are 3 UPS are paralleled, Set "Parallel device number" as "3".
Notice: Setting the "Parallel device address" as "2" will cause communication fail, please reset "device address" as "2" in menu "Communication Setting" to reconnect UPS.
5. Connect UPS3# and set "System Work Mode" as "Parallel Operation", "Parallel device number" as "3", "Parallel device address" as "3" in the menu "Parameter Setting".

You also can set the "Parallel mode" and "Parallel ID" by the LCD.

1. Power on the UPS1#, Press and hold "▲" to enter the setting mode, Press "◀" or "▶" to "PAR" and "Id", Set "Parallel mode" as "ON" and "Parallel ID" as "1". Press "◀" or "▶" to select, press "▲" to confirm selection
2. Power on the UPS2#, Press and hold "▲" to enter the setting mode, Press "◀" or "▶" to "PAR" and "Id", Set "Parallel mode" as "ON" and "Parallel ID" as "2". Press "◀" or "▶" to select, press "▲" to confirm selection



Recycling information in accordance with the WEEE

The product is marked with the wheelie bin symbol. It indicates that at the end of life the product should enter the recycling system.

You should dispose of it separately at an appropriate collection point and not place it in the normal waste stream.

The figure below shows the wheelie bin symbol indicating separate collection for electrical and electronic equipment (EEE).

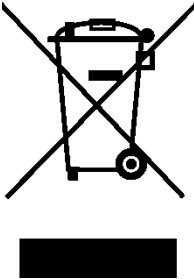

The Horizontal bar underneath the crossed-out wheelie bin indicates that the equipment has been manufactured after the Directive came into force in 2005.

The main parts of the drive can be recycled to preserve natural resources and energy. Product parts and materials should be dismantled and separated.

Contact your local distributor for further information on environmental aspects. End of life treatment must follow international and national regulations.