

Table of Contents

1	Safety Information	1
2	Product Overview	3
2.1	Specifications	3
2.2	Front panel features	5
2.3	Rear panel features.....	5
3	Installation	7
3.1	Unpacking inspection	7
3.2	Single System Installation	7
3.3	Parallel System installation	10
4	Operation Instructions	15
4.1	Display panel.....	15
4.2	UPS settings	19
4.3	Parameters inquiry	25
4.4	Event log query	26
4.5	UPS On / Off operation	27
4.6	Connect the communication.....	29
5	Operation Modes	32
5.1	Power-up mode / Shutdown mode	32
5.2	Standby mode	32
5.3	Bypass mode	33
5.4	Mains power mode (Frequency conversion mode)	34
5.5	Battery mode / battery self test mode.....	35
5.6	ECO mode	36
5.7	Fault mode	37
5.8	Maintenance bypass (manual operation)	38
5.9	Test mode	38
6	Maintenance and Troubleshooting	39
6.1	Use and maintenance of battery	39
6.2	UPS maintenance	40
6.3	Maintenance safety precautions.....	41
6.4	Troubleshooting	41

1 Safety Information

CAUTION

Non-qualified electricians are forbidden to open the case due to hazard of electrical shock.

Consulting the dealer is required before using for below equipment. Its application, configuration, management and maintenance must be specially considered and designed.

- Medical equipment which is directly related to patients' life
- Elevator and other equipment which may endanger personal safety

WARNING











The UPS must be properly earthed / grounded and due to a high leakage current, the earthing / grounding conductor must be connected first.

Safety and General Information

- Read all safety information and operating instructions carefully before attempting to install, operate, service or maintain the UPS.
- The UPS contains internal batteries and may present a shock hazard even when disconnected from the branch circuit (mains).
- The protective earth conductor for the UPS carries the leakage current from the load devices (computer equipment). An insulated ground conductor is to be installed as part of the branch circuit that supplies the UPS. The conductor must have the same size and insulation material as the grounded and ungrounded branch circuit supply conductors.
- Do not use liquid extinguisher if there is a fire, a dry powder extinguisher is recommended.
- Disconnect all connection wiring before maintenance or cleaning to avoid the risk of electric shock.
- Do not dispose of the batteries with fire. The batteries may explode.

- Do not open or mutilate batteries. Released electrolyte inside is harmful to the skin and eyes, and maybe toxic.
- Do not connect the positive pole and negative pole directly, otherwise it will cause electric shocks or will be on fire.
- It is not suitable to connect some electric equipment such as hair drier and heating appliance.

Note: Symbol instructions

Symbol	Significations	Symbol	Significations
	Caution		Protective earth
	Danger! High Voltage!		Disable/mute audible alarm
ON	Turn on		Bypass
OFF	Turn off		Battery inspection
	Standby or Shutdown		Repeat
	AC		Battery
	DC		

2 Product Overview

2.1 Specifications

MODEL	10 kVA	15 kVA	20 kVA	30 kVA
Capacity	10 kVA / 9 kW	15 kVA / 13.5kW	20 kVA / 18 kW	30 kVA / 27 kW
INPUT				
Nominal voltage	360 V / 380 V / 400 V / 415 Vac three-phase (3Φ+N+PE)			
Voltage range	277 ~ 485 Vac (no derating) 190 ~ 277 Vac (linear derating between 50% and 100% load)			
Rated frequency	50 / 60 Hz (auto-sense)			
Frequency range	40 ~ 70 Hz			
Power factor	≥ 0.99			
Bypass voltage range	-40% ~ +15% (settable)			
OUTPUT				
Nominal voltage	360V / 380V / 400V / 415 Vac three-phase (3Φ + N + PE) (settable)			
Voltage regulation	± 1%			
Frequency	Synchronized with utility in utility mode; 50 / 60 ± 0.1 Hz in battery mode			
Power factor	0.9			
Crest factor	3:1			
Total harmonic distortion (THDV)	≤ 2% (linear load); ≤ 5% (non-linear load)			
Transfer time	Mains mode to battery mode: 0 ms; Inverter mode to bypass mode: 0 ms			
Inverter overload capability	102% ~ 125%: transfer to bypass in 10 min; 125% ~ 150%: transfer to bypass in 1 min; > 150%: transfer to bypass in 0.5 s			
BATTERY				
DC voltage	Standard model: 240 Vdc; Long time model: 192 Vdc (168V / 192 V / 216 V / 240V optional)			

Inbuilt battery of standard model	20 * 7 Ah	40 * 7 Ah	40 * 9 Ah	60 * 9 Ah
SYSTEM				
Efficiency	Line mode: ≥ 93%; ECO mode: ≥ 98			
Display	LCD + LED			
Alarm	Battery mode, low battery, fans fault etc.			
Max. parallel numbers	6			
Protections	Short-circuit – overload – overtemperature – low battery – overvoltage – undervoltage – fans fault			
Communications	RS232 / USB / EPO (standard) ; RS485 / AS400 / SNMP (optional)			
OTHERS				
Operating temperature	0 ~ 40°C			
Relative humidity	< 95% (non-condensing)			
Noise level	≤ 60 dB (1m)	≤ 65 dB (1 m)		
IP rating	IP 20			
Dimensions (W * D * H) (mm)	350 × 655 × 732 (H)			
	350 × 785 × 858 (S)	350 × 785 × 1078 (S)		
Packaged dimensions (W * D * H) (mm)	472 × 780 × 920 (H)			
	472 × 910 × 1050 (S)	472 × 910 × 1260 (S)		
Net weight (kg)	55 (H), 110 (S)	60 (H), 155 (S)	61 (H), 175 (S)	65 (H), 235 (S)
Gross weight (kg)	65 (H), 125 (S)	70 (H), 170 (S)	71 (H), 190 (S)	75 (H), 250 (S)

H means Long time model w/o inbuilt battery; S means Standard model with inbuilt battery. Derate capacity to 90% when the output voltage is adjusted to 360 Vac.

2.2 Front panel features

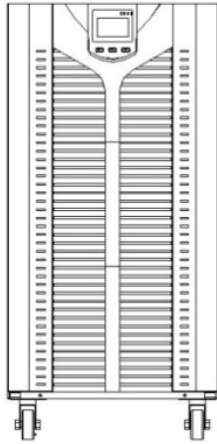

Front panel of long time model UPS

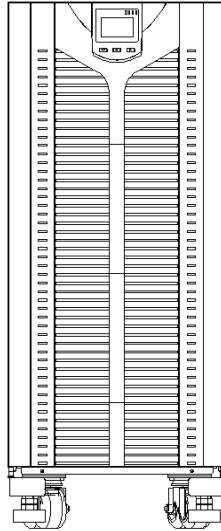

Front panel of 10 kVA standard model UPS (1 floor batteries)

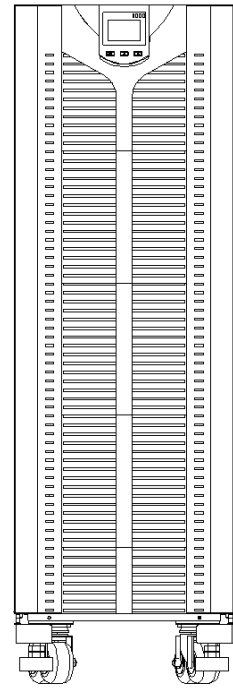

Front panel of standard model UPS (3 floors batteries)

2.3 Rear panel features

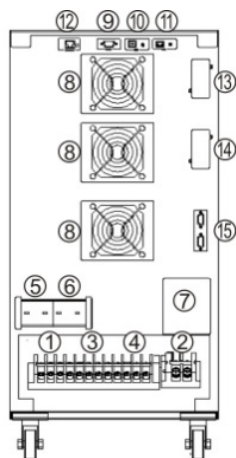

Rear panel of 10 kVA long time model UPS

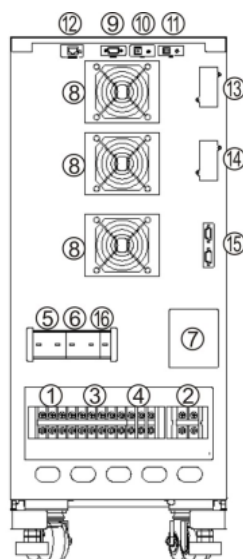

Rear panel of 10 kVA standard model UPS (1 floor batteries)

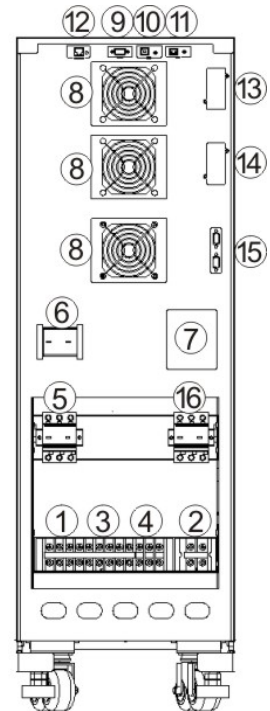

Rear panel of 10 kVA standard model UPS (3 floors batteries)

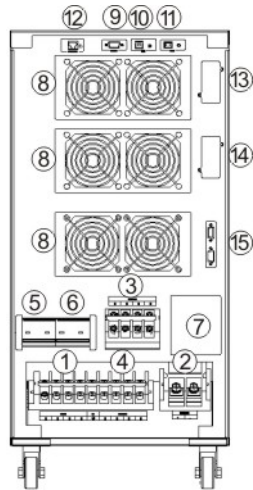

Rear panel of 15 k / 20 k /
30 k long time model UPS

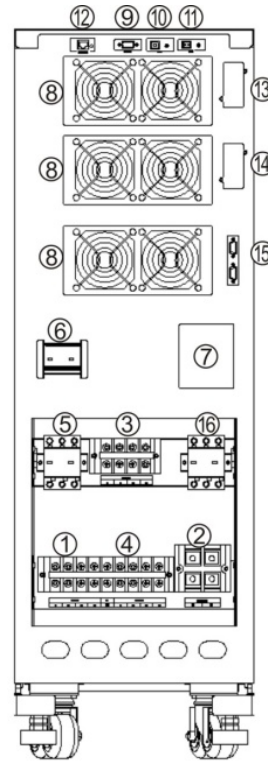

Rear panel of 15 k / 20 k /
30 k standard model UPS

1、 Main input terminal	9、 RS232 port
2、 Battery input terminal	10、 USB port
3、 Bypass input terminal	11、 EPO
4、 Output terminal	12、 Battery temperature compensation sensor (optional)
5、 Main input breaker	13、 Intelligent slot 1 (SNMP / AS400 / RS485 optional)
6、 Bypass input breaker	14、 Intelligent slot 2 (SNMP / AS400 / RS485 optional)
7、 Maintenance switch	15、 Parallel port (optional)
8、 Fan	16、 Inbuilt battery breaker

3 Installation

3.1 Unpacking inspection

- Open the UPS package and inspect the contents upon receipt. The accessories attached to the UPS contain a user manual, RS232 & USB communication cable, CD-ROM.
- Check if the unit is damaged during transport. Do not power on and notify the carrier and dealer if find damaged or parts missing.
- Verify this unit is the model you want to buy. Check the model name showed both on the front panel and rear panel.

Note:

Keep the packaging box and packaging materials for reuse. The equipment is heavy. Always handle it with care.

3.2 Single System Installation

 **CAUTION**

- When connect the loads with the UPS, turn off all the loads first, then connect power cables and turn on the loads one by one.
- UPS must be connected to the distribution board with overcurrent protective breaker.
- All power cables should be connected to the protective earthing.
- No matter whether connects the input power cables or not, the UPS output may present electricity. To make the UPS have no output, turning off the UPS first is required, and then disconnects the mains power supply.
- To connect inductive loads such as motor and laser printer etc., due to their excessive starting power, UPS capacity should be calculated by starting power which normally is twice as much as its rated power.
- If connect to a generator, follow this procedure:
- Turn on the generator, wait until it works normally and connect its output to the UPS input terminal (Verify that UPS has no-load at this moment), then start up

the UPS and connect the loads one by one (it is suggested that users choose the generator which is 1.2 times bigger than UPS capacity). If the generator has no enough endurance ability to shock (it shows switching to battery mode due to utility high voltage), it can be switched to bypass mode to take loads and then start UPS again to go to utility mode.

- For standard model UPS, it is suggested that users charge batteries more than 8 hours before using. Once mains input power is connected, the UPS can automatically charge the battery. Even not charge, it can be used at once, but its backup time will be less than standard value.
- After finishing installation, verify that the installation is correct.
- If install the protective leakage current switch, it should be installed on the UPS output terminal.

3.2.1 Installation environment and location

- Install the UPS system in a temperature controlled environment free of conductive contaminants and humidity.
- Install the UPS system on a non-flammable, level and solid surface (e.g. concrete) that can support the weight of the system.
- The UPS system cannot be placed up against the wall. Keep adequate space for proper ventilation of air inlet in the bottom of front panel, air outlet of fans on the rear cover plate and air inlet of enclosure sides.
- The ambient temperature of the UPS should be 0 °C to 40 °C.
- There may be condensing If unpacking in low temperature, the UPS must be waited until inside and outside of the UPS are completely dry for installation, otherwise there is hazard of electric shock.
- Place the UPS close to the mains input power distribution so as to cut off mains input switch and power supply in emergency situation.

3.2.2 Wiring

The UPS system uses terminal block for input and output connections.

The requirements for the cable current are as follows:

Model	Maximum current (A)			
	Mains / Bypass input	Output	Battery	N wire
10 kVA	24	24	60	42
15 kVA	35	35	94	61
20 kVA	46	46	125	79
30 kVA	60	60	180	116

Remark: when the main load is a kind of linear load, the N line cable can be selected the same cross sectional area as the mains live line cable; when the main load is a kind of non-linear load, the Null current is 1.5-1.7 times as big as the Live current, and it needs to be selected according to the recommended N line cable current in the above table. If it is multiconductor cable, it should be selected according to the cross sectional area of the N line cable.

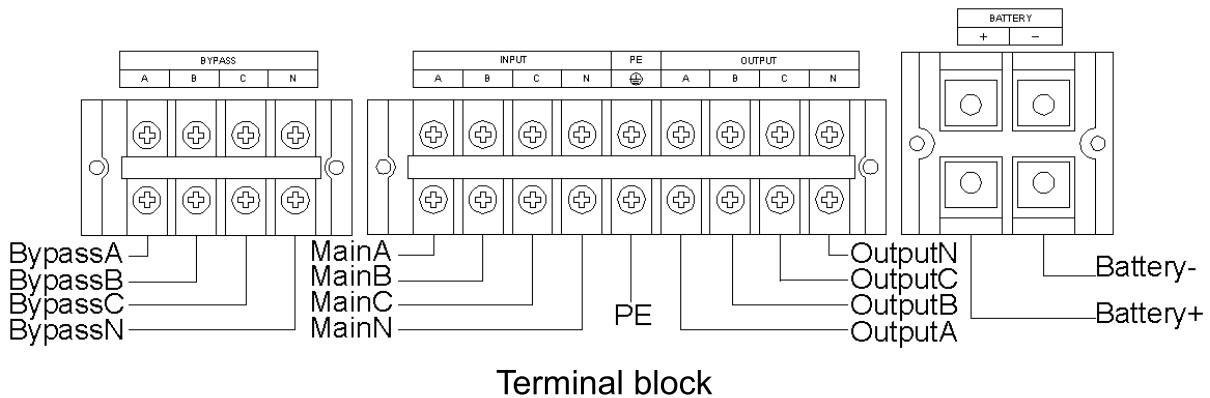

Note: Ensure that the input / output cables must be connected firmly to the input / output terminals, bad contacts are not allowable. It is suggested that the earth wire is close to the input / output wire size.

3.2.3 Connect external battery (Long time model UPS)

Notice: The default configuration of battery number is 16 pcs, the battery number can be modified via LCD panel or background software iServiceTool. If the UPS models are modified as long time model or standard model, the battery number will not change. If it was customized to be 14 / 16 / 18 / 20 pcs before factory delivery, connect proper batteries according to the customized battery quantity. If need to change battery configuration, contact your local dealer for modification. It needs to ensure that when modifying the number of battery: the actual number of battery, the number of battery set via charger and the number of battery set via background software or LCD panel should be kept consistent with each other.

- Strictly follow these steps:
 - ✧ Battery switch is OFF, connect batteries in series and ensure proper battery voltage.
 - ✧ Battery cables must be connected to the battery terminal first (Connecting to the UPS terminal first has hazard of electric shock), red wire is connected to BAT+, black wire to BAT-.
 - ✧ Use proper battery cables to connect the UPS and batteries. The DC breaker between UPS and batteries is required.
- Not to connect UPS to any loads first, close the battery breaker and provide mains power to the UPS (close the UPS input breaker), UPS will charge the battery group.

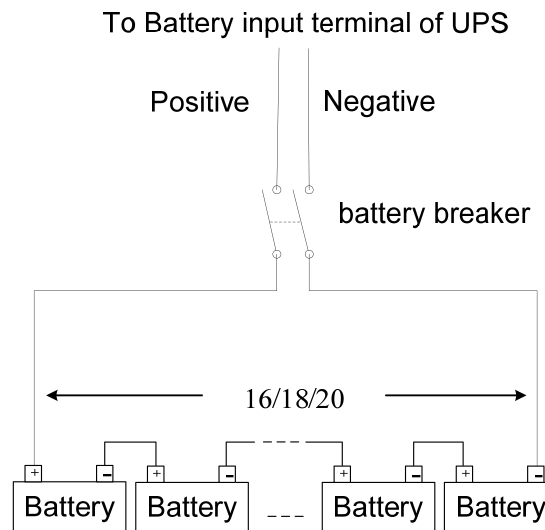

10-30 k long time model UPS battery connection

3.3 Parallel System installation

Parallel function is optional. Parallel kits include parallel card and parallel cables. The maximum parallel number is 6 units. Parallel UPS units must separately equip the battery group.

3.3.1 Parallel installation requirements

- Perform the input and output wiring of each UPS according to the wiring requirements of single UPS.
- The mains and bypass input cables of each UPS are connected respectively to

the same mains input wiring terminal.

- Each UPS output cable is connected to the output wiring terminal, and connected wiring to the load from the output wiring terminal.
- Each UPS requires separate battery group.
- Refer to the parallel wiring diagram. The switch size in the diagram is referred to the maximum current of terminal block to match.
- The output cable length requires: the cable length from each single UPS output to parallel UPS units output is almost same and more than 2 m at least. When the distance between the load and each parallel UPS is less than 20 m, each cable length difference less than 20% is required. When the distance between the load and each parallel UPS is more than 20 m, each cable length difference less than 10% is required.

3.3.2 Parallel installation procedure

- Install the parallel cables: when two UPS are paralleled, in order to ensure the reliability for parallel UPS units, there is only one way to connect the parallel cables, it is to make the parallel cable connected in loop line, follow the method of below drawing to connect the female port and male port, that is connecting two UPS with two parallel cables by parallel cards. For three or more parallel UPS units, the quantity of parallel cables needed equals to the UPS quantities. It just needs to connect each UPS in sequence with the parallel cables by parallel cards.

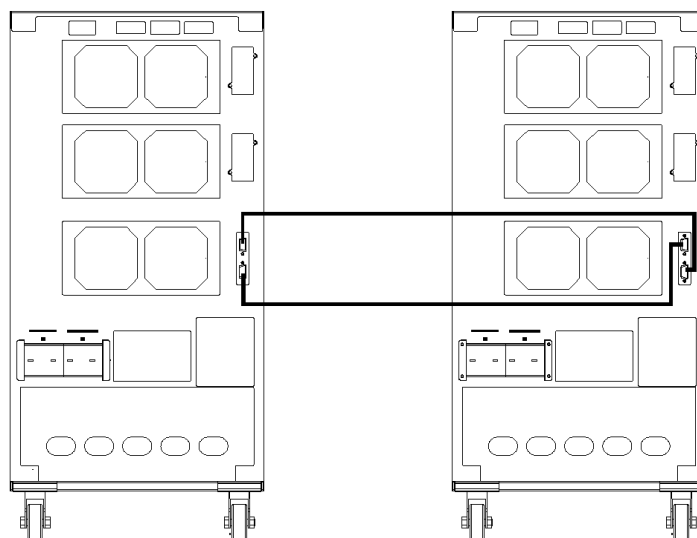

Parallel cable connection for two UPS

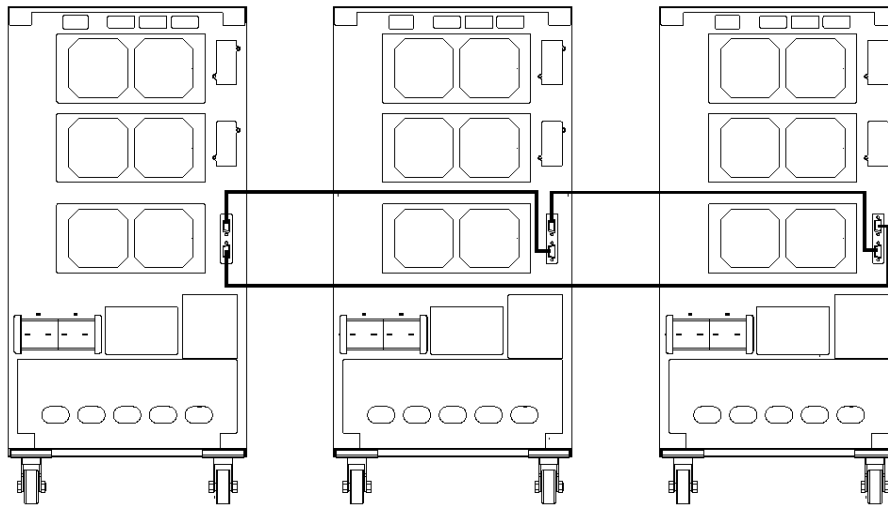

Parallel cable connection for three or more UPS

Note: For three or more parallel UPS units, removing the jumper cap of CN3 on the parallel card of the more unit than the third (including the third unit) is required, only keep the jumper cap of CN3 on the parallel card of the two UPS.

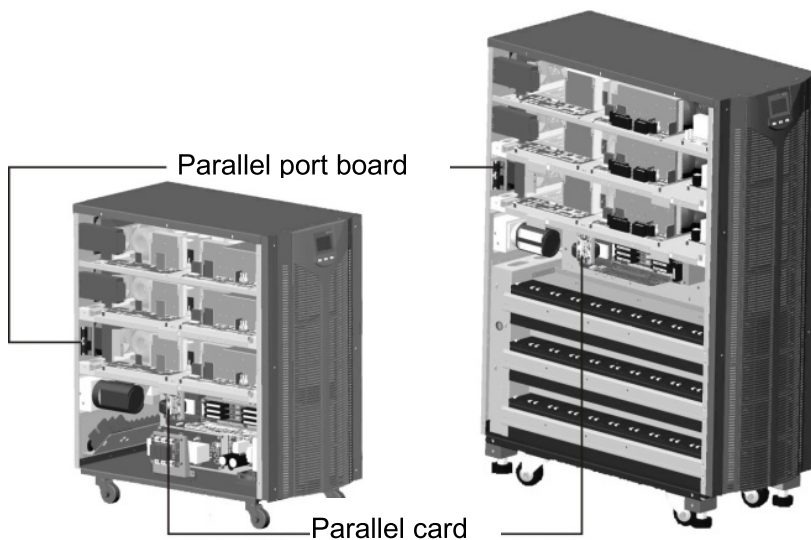

Parallel card of long time mode UPS Parallel card of standard mode UPS

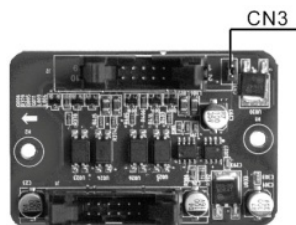

Short circuit cap of parallel card

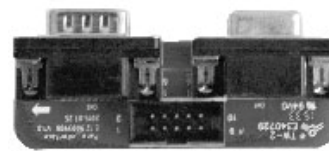

Parallel port board

- Connect all parallel UPS output cables to the output wiring terminal, and connect wiring to the load from the output wiring terminal.
- Connect all parallel UPS input cables to the input wiring terminal.

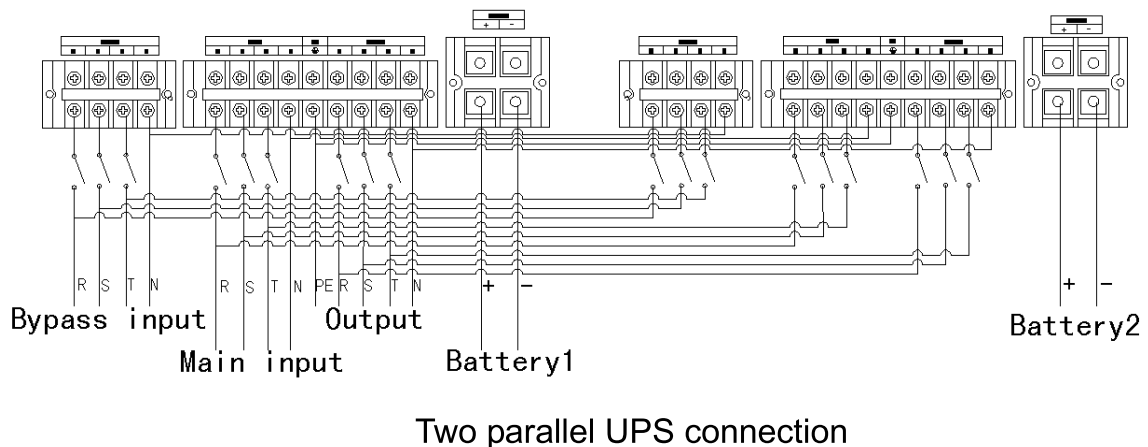
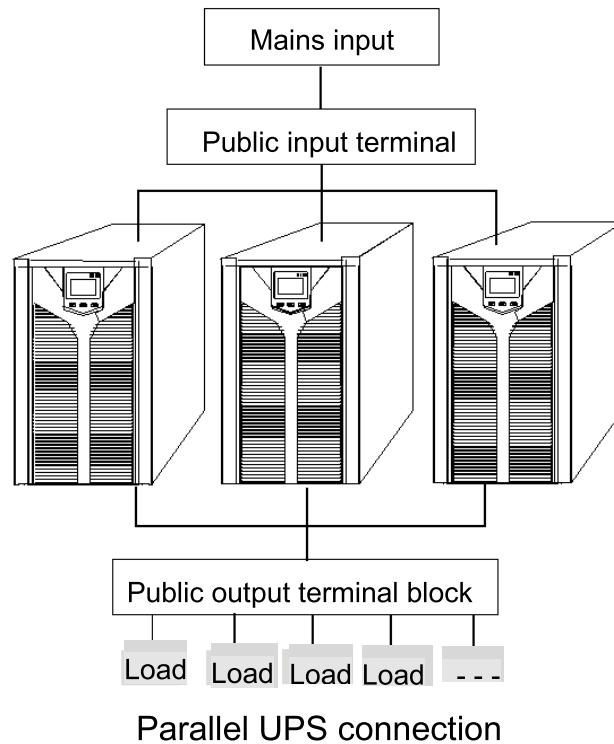

- For standard model UPS, each UPS has inbuilt battery group; for long time model UPS, it needs to equip separated external battery group.
- Verify all connection after parallel installation is completed. Operate the parallel UPS after confirming correct.
- In the condition of each single UPS running, set the physical address (ID) of each UPS, and ensure that each ID is different.
- In the condition of each single UPS running, set the output voltage (OPU) of each UPS, and ensure that each OPU is same.
- Verify if the parallel cables of all UPS are connected firmly, perform startup and finish parallel installation.

3.3.3 Parallel UPS operation

Follow single UPS operation requirements for general operation of parallel system. Before turning on the parallel UPS units, setting the physical address (ID) of each UPS is required, ensure each ID is different. Refer to panel settings operation for setting method details.

➤ **Start up parallel UPS**

✧ **Startup by mains power**

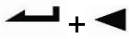

After access mains power, press the **Power ON** button  of any one of UPS more than half a second to start up parallel UPS. All UPS units will be turned on at same time, then meanwhile switch to inverter status, working in mains power mode.

✧ **Startup by the battery**

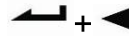
Method 1: After each UPS is connected to the normal battery, press key  of each UPS more than half a second ; after each UPS having working power source, press the **Power ON** button  of any one of UPS more than half a second to start up parallel UPS. All UPS units will be turned on at same time, then meanwhile switch to inverter status, working in mains power mode.

Method 2: After each UPS is connected to the normal battery, press key  of one UPS more than half a second; after this UPS having working power source, press the **Power ON** button  of this UPS more than half a second to start up parallel UPS. Wait for a period of time until the panel displays bAT, which indicates that this UPS is turned on successfully. Perform the same operation on other UPSs according to the above description.

✧ **Shut down parallel UPS**

Keep pressing the **Power OFF** button  of any one of UPS more than 4 seconds to turn off parallel UPS units; the system transfers to bypass output; it is turning off single UPS when bypass is abnormal. Press the **Power OFF** button  of any one of UPS more than half a second and less than 4 seconds to turn off the single UPS unit.

➤ **Parallel UPS system maintenance**

Follow single UPS maintenance requirements for parallel system maintenance. If one of parallel system UPS fails and need to maintain it, firstly it is required to cut off the breaker between input / output of the faulty UPS and parallel system, ensure that there is no electrical connection for the faulty UPS and parallel system, then disconnect all parallel cables of the faulty UPS and parallel system, and then make maintenance operation for the faulty one.

4 Operation Instructions

4.1 Display panel

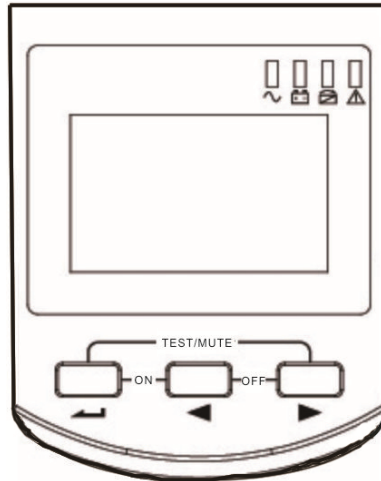





4.1.1 Buttons

- **Power ON** button (← + ◀)
Press the **Power ON** button more than half a second to turn the UPS on.
- **Power OFF** button (◀ + ▶)
Press the **Power OFF** button more than half a second to turn the UPS off.
- **Self Test / Mute** button (← + ▶)
 - In Mains mode, press and hold the buttons more than 1 second to perform UPS tests and diagnostic functions.
 - In Battery / Failure / Self test mode, press and hold the buttons more than 1 second to mute the alarm; press and hold the buttons more than 1 second again to cancel mute;
- **Menu settings** button/**Enter** button (←)
 - Menu settings: Press and hold menu setting button more than 2 seconds to enter the menu settings interface. After the setting is determined, press and hold menu setting button more than 2 seconds to return back to the main display interface.
 - Enter button: In menu setting interface, press and hold ← more than 0.2 second and less than 2 seconds to ensure the setting options.

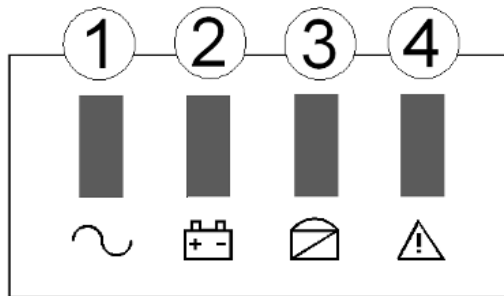
- **Page turning /Inquiry button** (◀ , ▶)
 - Page turning: Press ◀ or ▶ more than 0.2 second and less than 2 seconds to perform page turning from right to left or from left to right.
 - History inquiry: Press and hold ◀ more than 2 seconds to enter the history inquiry interface; press ◀ more than 2 seconds to turn back to the main display interface.

4.1.2 LED indicators



Icons	Function	Description
	Inverter indicator (Green)	<p>Illuminated: The UPS is working in inverter mode (such as mains power mode, battery mode, battery self test mode, ECO mode, frequency conversion mode).</p> <p>Unilluminated: The UPS is working in non-inverter mode.</p>
	Battery indicator (Yellow)	<p>Illuminated: The UPS is working in battery / battery self test mode.</p> <p>Unilluminated: The UPS is working in non-battery mode and non-battery self test mode.</p> <p>Flash: low battery alarm</p>
	Bypass indicator (Yellow)	<p>Illuminated: The UPS is working in bypass mode or ECO mode.</p> <p>Unilluminated: The UPS is working in non-bypass mode and non-ECO mode.</p> <p>Flash: g in standby mode, not starting frequency conversion and bypass abnormal</p>
	Alarm indicator (Red)	<p>Illuminated: UPS is faulty</p> <p>Unilluminated: UPS is normal</p> <p>Flash: the UPS emits an audible alarm</p>

4.1.3 LCD display

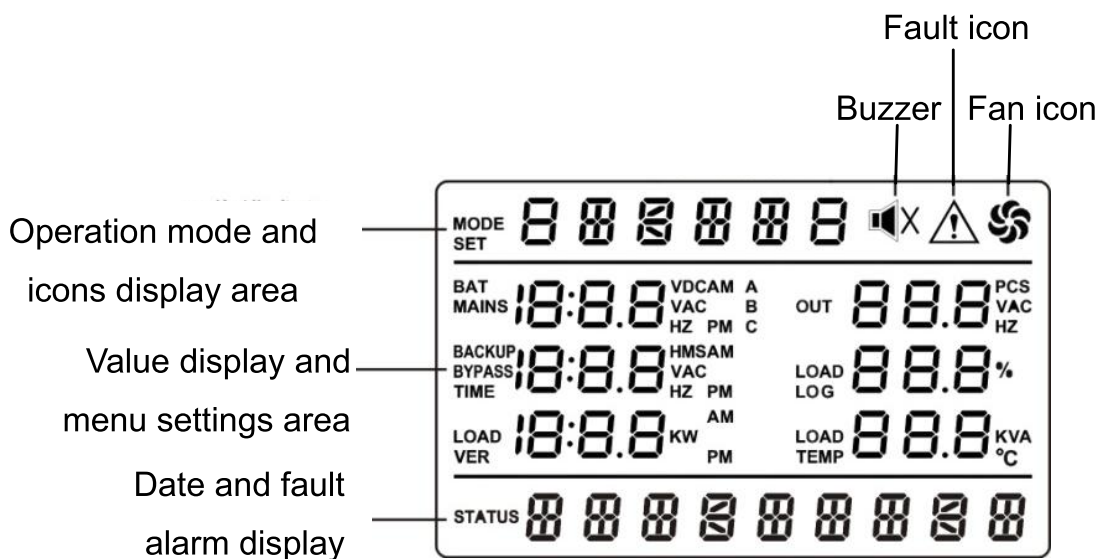

LCD display is divided into three areas: Operation mode and icons display area, value display and menu settings area and date and fault alarm display area.

❖ Operation mode and icons display area :

- 1) There are following contents in the area of display page
 - After starting up in 20 seconds, this display area mainly indicates the UPS power rating.
 - This display area mainly indicates the UPS operation mode in 20 seconds after starting up, such as STdbY (Standby mode), byPASS (Bypass mode), Line (Utility mode), bAT (Bttery mode), bATT (Bttery self test mode), FAULT (Fault mode), CUCF (Frequency conversion mode), ECO (economy control operation), SHUTdn (Shutdown mode), TEST (Test mode).
 - Fan icon indicates the working status of fans. Normally, the fan shows rotation status. The icon will flash if fans are disconnected or faulty; Buzzer icon indicates if the buzzer is mute. Normally, this icon doesn't display. Press the mute button in battery or fault mode or set MUTE ON via background software in any mode, the UPS will enter mute status and the buzzer icon will be illuminated. The fault icon is illuminated in fault mode, it doesn't display in other cases.

- 2) The area of menu setting page showing the settable menu options
- 3) The area of event log query page showing page number of history records

❖ **Value display and menu settings area:**

- In non-menu setting interface, it indicates the relevant information of UPS. Press the inquiry button ◀ or ▶ to display three phase mains input, bypass input, output voltage, frequency, load, battery voltage, capacity, backup time, temperature, Bus voltage, software version, etc.
- In menu setting interface, press the menu settings button and inquiry button to set output voltage value (OPU), checking status OFF (CHK), battery numbers(PCS), physical address(ID) and Enable (PAL).
- Press the inquiry button ◀ or ▶ to browse history records in history inquiry interface.

❖ **Date and fault alarm display area:**

If there is no any fault alarm information, it indicates the system date. If there is alarm, it scrolls the display to indicate current alarm information; If there is fault, it scrolls the display to indicate current fault information.

4.1.4 Equivalent UPS working status to the indicator

Buzzer sound	Description
Long beep	Fault mode
1 s per beep	Low battery in battery mode
	Output and bypass overload
2 min per beep	The inverter is not open
4 s per beep	All other alarms

No.	Working status	The panel indicator display				Audible alarm
		Normal	Battery	Bypass	Fault	
1	Utility mode / Frequency conversion mode					
	No any fault alarm	●				No
	Alarm exists	●			★	1/ 4 s per beep
2	Battery mode					

	Non-low battery alarm	•	•		★	4 s per beep
	Low battery alarm	•	★		★	1 s per beep
3	Battery self test mode / Starting process	★	★	★	★	4 s per beep
4	Bypass mode					
	No any fault alarm			•		2 min per beep
	Alarm exists			•	★	1/ 4 s per beep
5	ECO mode					
	No any fault alarm	•		•		No
	Alarm exists	•		•	★	1/ 4 s per beep
6	Fault mode				•	Long beep

• _ The indicator is illuminated.

★ _ The indicator flashes.







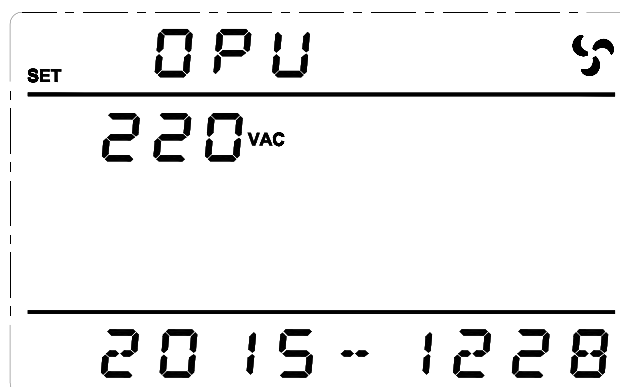

4.2 UPS settings

Although the UPS settings can be configured in any mode, it is suggested that it should be better to make the setting operation in standby mode. Contact with suppliers or after sales staff if need other configuration (frequency conversion mode, ECO mode ON, parameter adjustment, special menu settings etc.).

4.2.1 Configure the UPS output voltage (OPU)



Output voltage setting interface

- Press and hold the menu settings button  more than 2 seconds to enter settings interface. Press inquiry button  or  more than 0.2 second and less than 2 seconds to select the function options. After selecting the output voltage setup interface, OPU will flash.
- Press the menu settings button  more than 0.2 second and less than 2 seconds to enter the output voltage setting interface (OPU), at this moment OPU is illuminated, and the value under OPU flashes. Press inquiry button  or  more than 0.2 second and less than 2 seconds, select the corresponding values of OPU. There are 208V, 220V, 230V and 240V available for options. The default output voltage is 220V. The configured settings can be saved in real time.
- After selecting the value, press the menu settings button  more than 0.2 second and less than 2 seconds, OPU setup is confirmed, at this moment the value under OPU is illuminated and stop flashing.
- Press and hold the menu settings button  more than 2 seconds to exit the setting interface and return to the home screen.





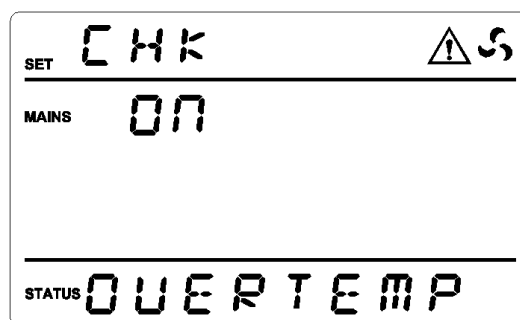



Note: Configure the output voltage setting of parallel UPS units in standby or bypass mode. The settings of single UPS unit can be configured in any mode.

4.2.2 Checking status (CHK)



Checking status setting interface



Power up again after power off in fault mode, the UPS enters checking status (CHK) and the panel displays the last fault information. Judge if keep bypass output and forbid turning on the UPS according to the fault information. It is not allowed to turn on the UPS until failure is solved and manually close CHK.

- Press and hold the menu settings button  more than 2 seconds to enter the setting interface. Press inquiry button  or  more than 0.2 second and less than 2 seconds to select the function options. After selecting CHK setting interface, CHK will flash.
 - Press the menu settings button  more than 0.2 and less than 2 seconds to enter the CHK setting interface, at this moment CHK is illuminated, and ON or OFF under the CHK flashes. Press inquiry button  or  more than 0.2 and less than 2 seconds and select ON or OFF. ON indicates that the maintenance status is enabled, OFF indicates that the maintenance status is disabled. Maintenance status is OFF by default and it is ON when powering on the UPS after removing fault, and settings are saved real-timely.
 - After selecting ON or OFF, press the menu settings button  more than 0.2 and less than 2 seconds, CHK Enable is confirmed, at this moment ON or OFF under the CHK is illuminated and stop flashing.
 - Press and hold the menu settings button  more than 2 seconds to exit the setting interface and return to the main display interface (or wait for at most 30 seconds, it will automatically skip to the main menu interface).
- Notice:** CHK option will appear on the setting interface after a fault occurs, and there is no CHK option when the UPS is normally.

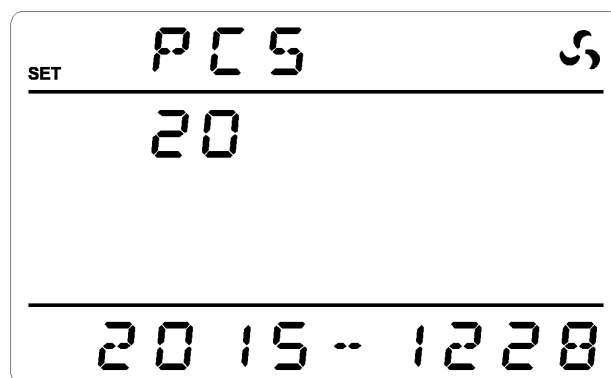



4.2.3 Numbers of battery (PCS)



Numbers of battery setting interface

- Press menu setting button  more than 2 seconds to enter the menu setting interface. Press inquiry button  or  more than 0.2 second and less than 2 seconds to select the menu, turn to Numbers of battery (PCS) setting page, PCS

will flash.

- Press the enter button  more than 0.2 second and less than 2 seconds to enter Numbers of battery (PCS) setting interface, at this moment PCS is illuminated, numerical value under PCS flashes. Press inquiry button  or  more than 0.2 second and less than 2 seconds to select different physical addresses. There are 14/16/18/20 pcs of batteries for options, and the settings will be saved in real time.
- Turn to the page of battery numbers needed, press the enter button  more than 0.2 second and less than 2 seconds, Numbers of battery (PCS) setting is finished, at this moment the numerical value under PCS is illuminated and stop flashing.
- Press menu setting button  more than 2 seconds to exit the setting interface, and get back to the main menu (or wait for at most 30 seconds, it will automatically skip back to the main menu interface).

Note: After back-end software setting the model (TyPE), the number of batteries (PCS) will not change accordingly. When setting the number of battery via the back-end software or panel, it should be ensured that the actual number of battery, the number of battery set via charger and the number of battery set via back-end software or LCD panel should be kept consistent with each other. You can set the battery number of the charger via the jumper, “000” indicates no mini jumper; “001” indicates plugging a mini jumper on the right of the arrow; “100” indicates plugging a jumper on the left of the arrow; “010” indicates plugging a jumper in the middle side. If the number of battery needs to be modified, please contact with the supplier.



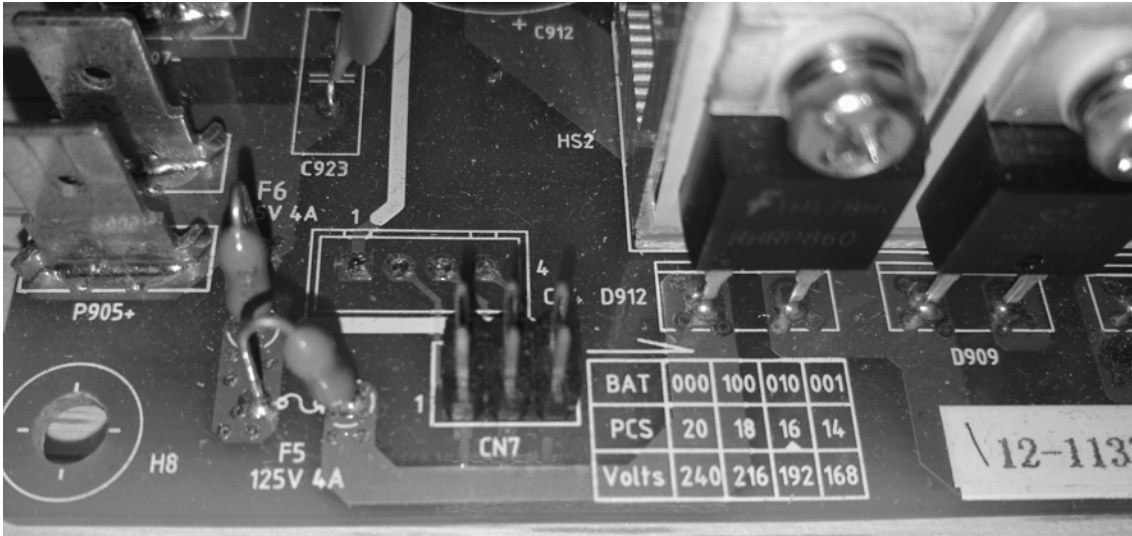

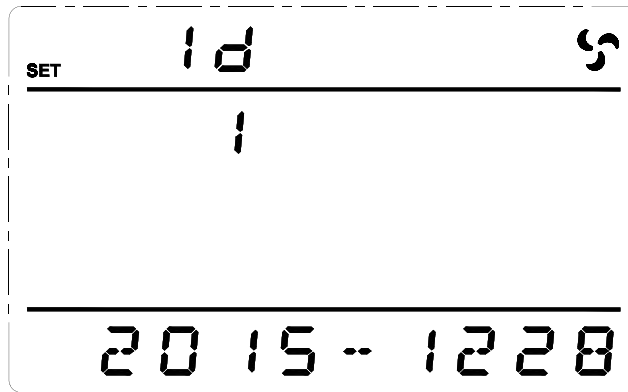

CN7 jumper	001	010	100	000
Number of battery	14	16	18	20



4.2.4 Configure the physical address (ID)



Physical address setting interface

- Press and hold the menu settings button  more than 2 seconds to enter the setting interface. Press inquiry button  or  more than 0.2 second and less than 2 seconds to select the function options. After selecting the ID setting interface, ID will flash.
- Press the menu settings button  more than 0.2 second and less than 2 seconds to enter the ID setting interface, at this moment ID is illuminated, and the value under the ID flashes. Press inquiry button  or  more than 0.2 second and less than 2 seconds to select different physical addresses. There are 1/2/3/4/5/6/7/8 available for options. The default address is 1. The configured settings can be saved in real time.
- After selecting the address, press the menu settings button  more than 0.2 second and less than 2 seconds, ID setup is confirmed, at this moment the selected value is illuminated and stop flashing.







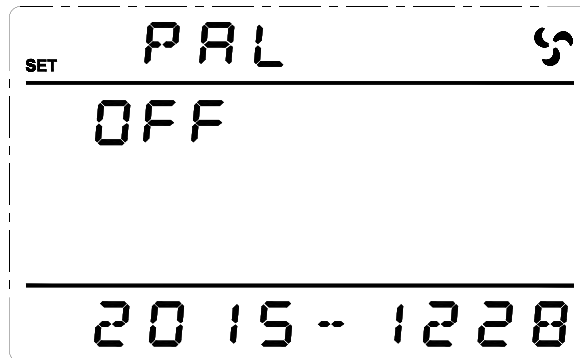

- Press and hold the menu settings button  more than 2 seconds to exit the setting interface and return to the home screen (or wait for at most 30 seconds, it will automatically skip to the main menu interface).

Note: The physical address setting can be only configured in case of single UPS operating, it cannot be done in parallel UPS units.

4.2.5 Configure parallel Enable (PAL)



Parallel Enable setting interface

- Press and hold the menu settings button  more than 2 seconds to enter the setting interface. Press inquiry button  or  more than 0.2 second and less than 2 seconds to select the function options. After selecting the PAL Enable setting interface, PAL will flash.
- Press the menu settings button  more than 0.2 second and less than 2 seconds to enter the PAL Enable setting interface, at this moment PAL is illuminated, and ON or OFF under the PAL flashes. Press inquiry button  or  more than 0.2 second and less than 2 seconds to select ON or OFF. ON indicates PAL Enable is on and OFF indicates PAL Enable is off. PAL is OFF by default. The configured settings can be saved in real time.
- After selecting ON or OFF, press the menu settings button  more than 0.2 second and less than 2 seconds, PAL Enable setup is confirmed, at this moment ON or OFF under PAL is illuminated and stop flashing.
- Press and hold the menu settings button  more than 2 seconds to exit the setting interface and return to the home screen (or wait for at most 30 seconds, it will automatically skip to the main menu interface).

Note: The single UPS unit will emit an alarm indicating PAL SET F after PAL Enable.
And it is forbidden to start the UPS.

4.3 Parameters inquiry

- Press inquiry button ◀ or ▶ more than 0.2 second and less than 2 seconds to inquire in sequence for some information about three-phase A / B / C main input, bypass, output, load, frequency, software version, temperature, battery, Bus voltage etc., 5 pages in total.
- Press and hold inquiry button ▶ more than 2 seconds to enter roll polling mode display, automatically switch display items in every 2 seconds, and go back to the main display interface in 30 seconds. If press and hold ▶ again within 30 seconds, it will go back to the main interface immediately.

Interface Page 1 (main interface): Display UPS phase A information, as shown below.

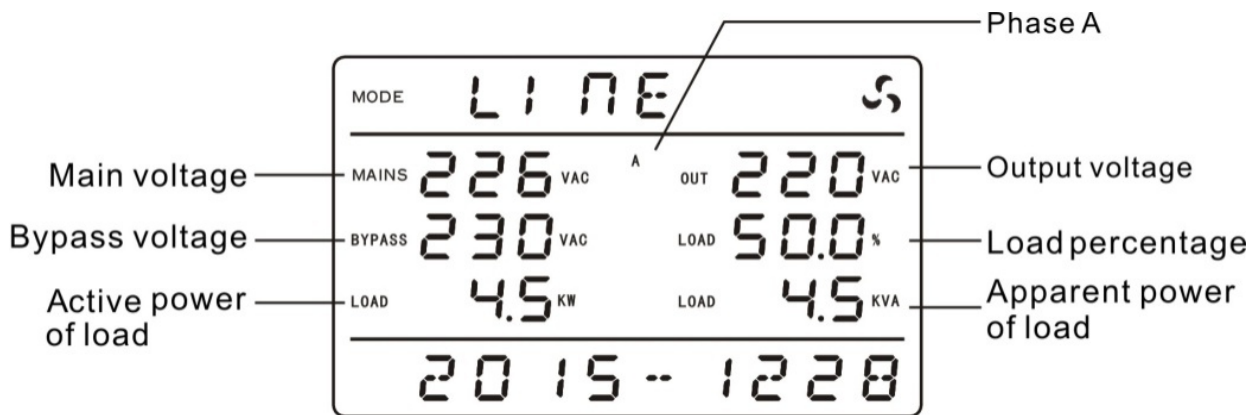

Interface Page 2: Display UPS phase B information, as shown below.

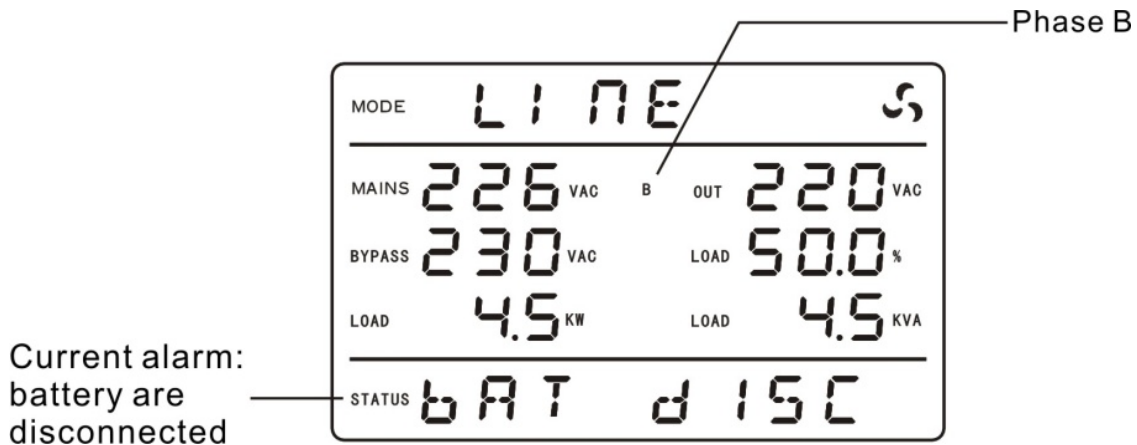

Interface Page 3: Display UPS phase C information, as shown below.

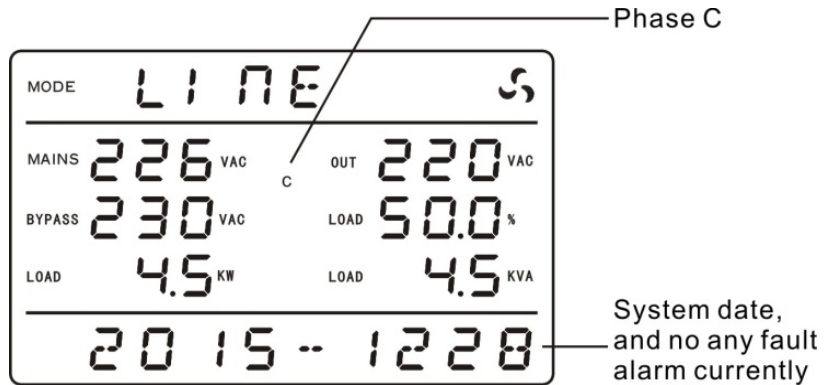

Interface Page 4: Display UPS frequency information, temperature and software version, as shown below:

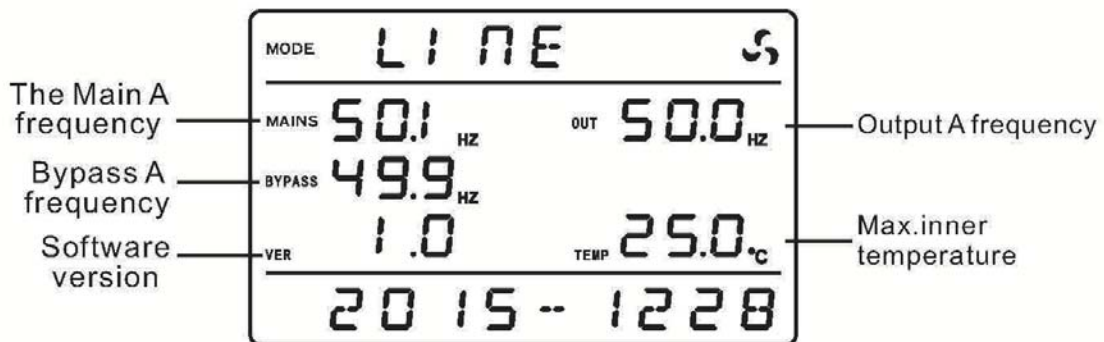

Interface Page 5: Display UPS battery voltage, battery capacity percentage, BUS voltage, as shown below.

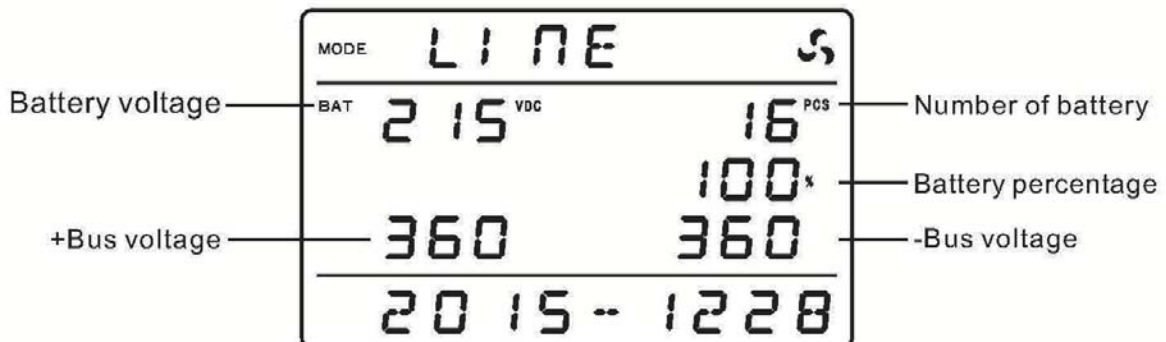

4.4 Event log query

Press and hold the inquiry button ◀ more than 2 seconds to enter Event log query interface; Press inquiry button ◀ or ▶ more than 0.2 second and less than 2

seconds to look over event logs with page turning. There are maximum 200 pages (600 pieces) event logs records. Press and hold the inquiry button ◀ more than 2 seconds again to return to the home screen.

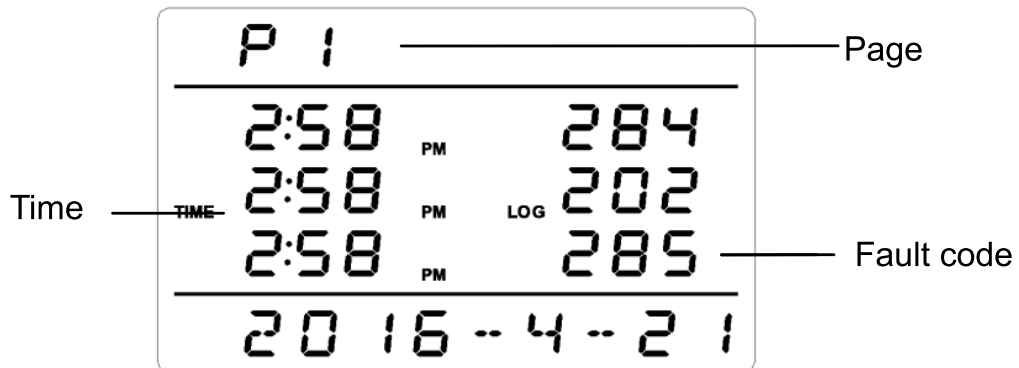

Event logs query is for qualified personnel use only.

4.5 UPS On / Off operation

Operation	Description
<p>Turn on the UPS</p>	<p>When proper battery or main input is connected, the UPS can be turned on.</p> <ul style="list-style-type: none"> <p>Turn on the UPS by mains power</p> <p>Connect normal mains input, LCD panel displays STdbY or bypass, press Power ON button ◀+◀ more than half a second to turn the UPS on. LED indicator is illuminated circularly in turn and lights go out in turn. After waiting for a while until the display panel showing LinE, turning on the UPS is completed and enter mains power mode.</p> <p>Turn on the UPS by batteries</p> <p>Connect normal batteries, press menu setting/enter button ◀ more than half a second, the display screen is illumined, and display STdbY, UPS has working power supply, then press Power ON button ◀+◀ more than half a second to turn the UPS on. LED indicator is illuminated circularly in turn and lights go out in turn. After waiting for a while until the display panel showing bAT, turning on the UPS is completed and enter battery mode.</p>

<p>Turn off the UPS</p>	<ul style="list-style-type: none"> In Mains power / battery mode / battery self test / ECO / frequency conversion mode, press Power OFF button ◀ + ▶ more than half a second to turn off the UPS. If bypass is normal, UPS panel displays byPASS to enter bypass mode, if bypass is abnormal or the UPS is in frequency conversion mode, UPS panel displays STdAby to enter standby mode and the output is disconnected. If turn off the UPS in bypass mode, UPS enter to standby mode and the output is disconnected.
<p>Self-test operation</p>	<ul style="list-style-type: none"> In Mains power / ECO / frequency conversion mode and when the battery voltage is higher than the low voltage alarm point, press Self Test / Mute button ◀ + ▶ more than 1 second and wait for 10 seconds, LED indicator is illuminated circularly in turn and lights go out in turn, LCD display bATT, the UPS enters battery self test mode and automatically exit after finishing diagnosing, and then LED and LCD restore previous state.
<p>Mute operation</p>	<ul style="list-style-type: none"> In battery / battery self test / fault mode, press Self Test / Mute button ◀ + ▶ more than 1 second, UPS panel displays buzzer disable icon, the alarm buzzer will silence. If press Self Test / Mute button ◀ + ▶ more than 1 second again, the buzzer starts beeping, the buzzer disable icon is eliminated. In any modes, MUTE ON is configurable by LCD panel to make the UPS mute. Note: It is not allowed to make the UPS mute in low battery; if setting mute in fault mode, the mute will be automatically cancelled in one day, and troubleshooting soon is required.
<p>Operation in audible alarm status</p>	<ul style="list-style-type: none"> When the buzzer is beeping and the fault indicator is flashing, it indicates that the UPS is in alarm status, troubleshooting can be done by the alarm information displayed on the LCD panel.
<p>Operation in fault mode</p>	<ul style="list-style-type: none"> When the sound of the UPS buzzer lingers on and the fault indicator is illuminated, it indicates that the UPS enter fault mode, contact your supplier or after-sales personnel and provide them with failure information.

4.6 Connect the communication

4.6.1 Computer port

Connect the UPS and monitoring equipment (computer) by standard RS232 port (standard configuration) and standard USB port (standard configuration) to make single unit communication.

- Connect RS232 (or USB) cable to the serial port of the computer (or USB port);
- Connect RS232 (or USB) cable to the serial port of the UPS (or USB port);

❖ RS232 port

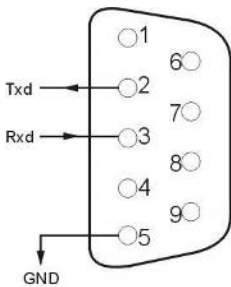

Pins	1	2	3	4	5
Definition	Empty	Transmit	Receive	Empty	GND
Pins	6	7	8	9	
Definition	Empty	Empty	Empty	Empty	

❖ USB port

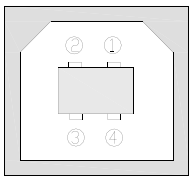

Pins	1	2	3	4
Definition	Power source + 5 V	Data+	Data -	GND

4.6.2 EPO port

The Emergency Power Off (EPO) is a feature that will immediately disconnect all connected equipment from mains power. The EPO port is on the rear panel of the UPS with green terminals. EPO can be set as transferring bypass, disconnected output and disabled. When the UPS is delivered, the EPO function is defaulted as disabled; if the EPO function is to be used, it needs to set via the back-end software iService Too. Its connection is as follows:

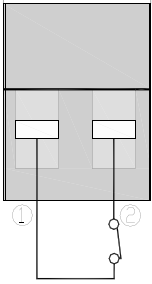

In normal condition, pins ① and pins ② are closed ;
when performing Emergency Power Off, disconnect pins ① and pins ②.

4.6.3 Intelligent cards (optional)

The UPS has two intelligent slots for SNMP card (upper slot), dry contacts card and RS485 card (lower slot). Intelligent cards are installed in the intelligent slots on the UPS rear panel, and there is no need to stop the UPS during installation. The installation procedure is as follows:

- Remove the cover plate of the intelligent slots
- Insert the required intelligent card into the slot
- Tighten the screws

❖ SNMP card (optional)

SNMP is used in network management systems to communicate, manage and monitor UPS devices, it could be compatible with current popular software, hardware and network operating system.

❖ Dry contacts card (optional)

Insert dry contacts card into the intelligent slot to monitor and manage the UPS.

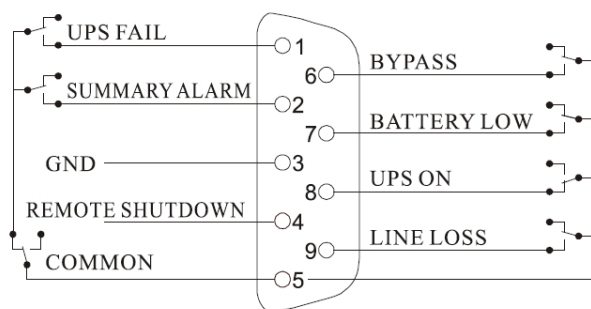

Pins	Definition
PIN 1	Close: UPS fault
PIN 2	Close: Alarm sounds (system fault)
PIN 3	Grounding
PIN 4	Remote shutdown
PIN 5	Common
PIN 6	Close: bypass working
PIN 7	Close: low battery
PIN 8	Close: UPS working Open: bypass working
PIN 9	Close: Mains power Off

❖ **RS485 card (optional)**

A and B on the right side of ports are RS485 output, A is “+”, B is “-”.



4.6.4 Maintenance switch

Maintenance switch is for UPS on-line maintenance, follow below procedures:

- Open the cover plate of the maintenance switch on the UPS rear panel, the UPS will automatically transfer to bypass to supply power to the load.
- Make the maintenance switch at “BYPASS”.
- Disconnect all input / battery breakers.
- Wait until the display screen is extinguished completely and on standing for 10 mins, make sure there is no hazard of electrical shock inside the UPS, and you can do on-line maintenance for the UPS.
- After finishing on-line maintenance, close the input breaker first, then make the maintenance switch at “UPS” end, and then install the cover plate of the maintenance switch.

Note: Make sure the system bypass is normal and not to start frequency conversion, otherwise it may cause power failure or even damage to loads.

If the UPS has no output and needs manual on-line maintenance, disconnect all input breaker and ensure the UPS display screen is extinguished, then put the maintenance switch to “BYPASS” by hand, otherwise it may cause damage to the UPS.

5 Operation Modes

This UPS is a kind of on-line dual conversion UPS, which has following operation modes:

- Power-up mode (LCD display power capacity)
- Standby mode (Stdby)
- Bypass mode (byPASS)
- Mains power mode (LInE)
- Battery mode (bAT)
- Battery self test (bATT)
- Fault mode (FAULT)
- Frequency conversion mode (CUCF)
- Economy control operation (ECO)
- Shutdown mode (SHUTdn)
- Test mode (TEST)
- Maintenance bypass mode (manual operation)

5.1 Power-up mode / Shutdown mode

In the condition of power off and the display screen being black out, connect batteries and press first key  or connect mains power or connect bypass to illuminate the screen, the UPS gets into power-up mode, all illuminated LED indicators are turned into off (as shown in the figure below), meanwhile LCD display power capacity (10 kVA / 15 kVA / 20 kVA / 30 kVA).

In standby mode, the UPS detects that mains power and bypass three phase all are less than 85 V, it will delay 1 min to automatically enter shutdown mode, all LED indicators are turned off, meanwhile LCD display SHUTdn characters.



5.2 Standby mode

There is no output voltage in standby mode. If mains circuit input is normal, then automatically process AC / DC rectification, after rectifying automatically start the charger charging batteries.

All LED indicators are turned off in standby mode operation (as shown in the figure below), meanwhile LCD display Stdby characters.

There are several situations as follows to enter standby mode:

- Bypass is abnormal after the UPS is powered up (including frequency conversion enable) and the UPS isn't turned on;
- In mains power mode / battery mode / frequency conversion mode, shut down the UPS when bypass is abnormal;
- Shut down the single UPS unit when inverter of parallel UPS units is operating;
- Exit fault mode and bypass is abnormal;

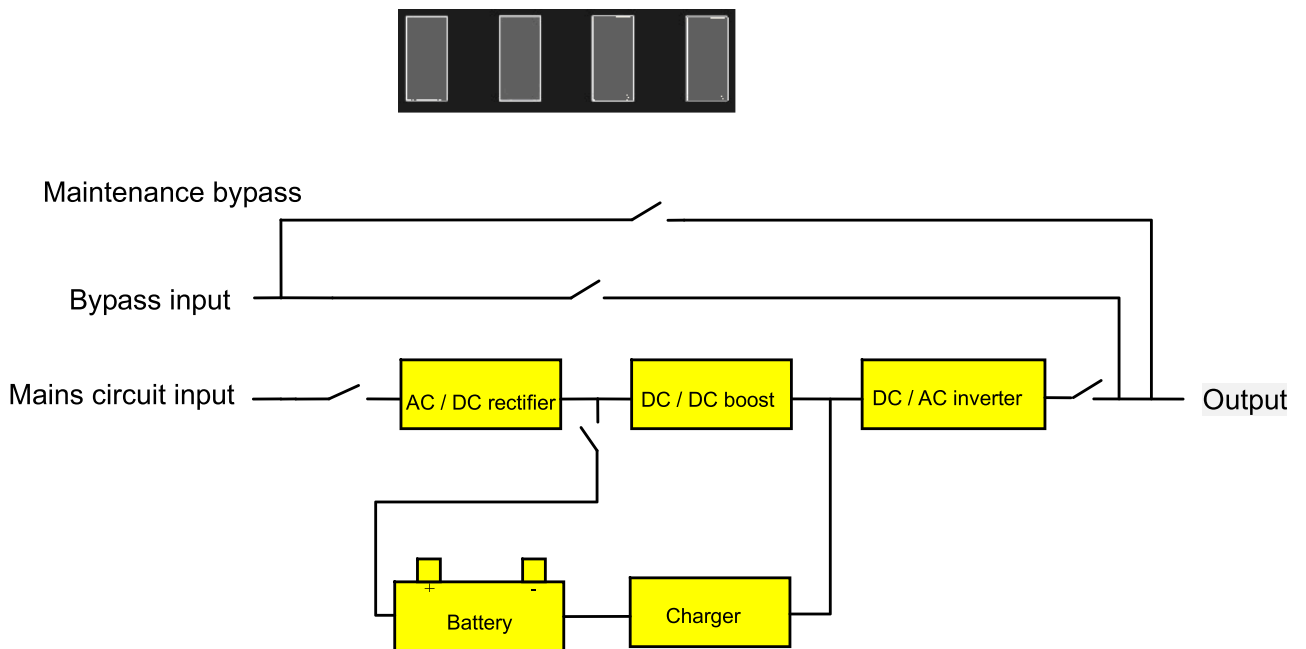

Standby mode operation process

5.3 Bypass mode

In bypass mode, mains power of bypass input goes through the filter to the load. If mains circuit input is normal, then automatically process AC / DC rectification, after rectifying automatically start the charger charging batteries.

LED indicator in bypass mode is as shown in the figure below (white color indicates illuminated status), meanwhile LCD display byPASS characters.



There are three situations as follows to enter bypass mode:

- Bypass is abnormal after the UPS is powered up (including frequency conversion enable) and the UPS isn't turned on.
- Shut down in mains power mode, overload or overtemperature
- Exit fault mode and bypass are normal

When bypass is normal, turn off the UPS or the inverter circuit has failure, the UPS transfer to bypass mode to supply uninterruptible power to the load.

Note: Bypass mode doesn't have function of backup.

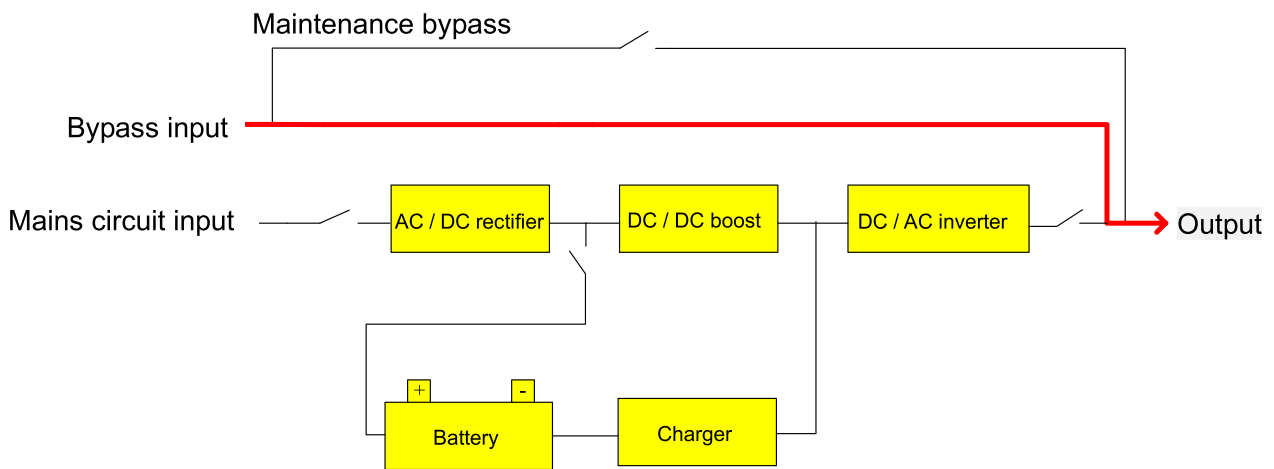

Bypass mode operation process

5.4 Mains power mode (Frequency conversion mode)

In mains power mode, the mains power from mains circuit input supply AC power to the UPS rectification, and supply DC power to the inverter circuit after PFC power factor correction, and then supply uninterruptible AC power to the load via the inverter circuit. After the inverter startup, automatically start the charger charging batteries.

LED indicator in mains power mode is as shown in the figure below: the inverter LED indicator (green) is illuminated, meanwhile LCD display LinE characters.



Note: The inverter output frequency in frequency conversion mode is configured output frequency and cutting off bypass is necessary; the inverter output frequency in mains power mode is related to bypass frequency (the default is 50 Hz when bypass is abnormal and frequency conversion disenable). Please contact with supplier or after sales staff if need to set frequency conversion mode.

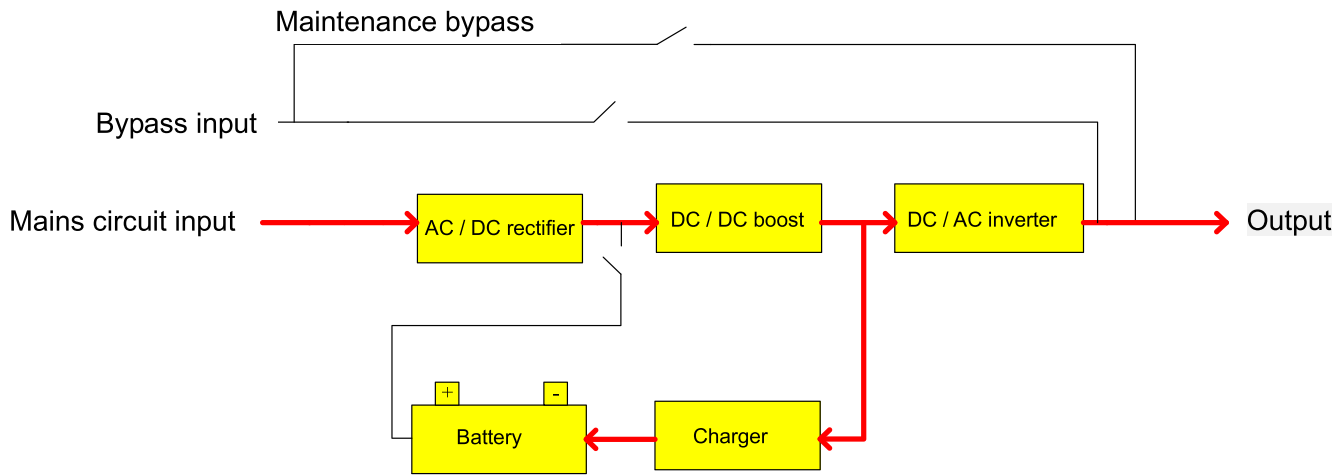

Mains power mode operation process

5.5 Battery mode / battery self test mode

In battery mode, the batteries go through DC / DC boost and supply DC voltage to the inverter, and then supply AC power to the load via the inverter circuit.

LED indicator in battery mode is as shown in the figure below: the inverter LED indicator (green) is illuminated and battery LED indicator (yellow) is illuminated, and alarm LED indicator (red) flashes while giving alarm, meanwhile LCD display bAT characters.

When the batteries process in manual self-test and regular self-test, the inverter indicator, bypass indicator, battery indicator and fault indicator will be illuminated circularly, meanwhile LCD display bAT characters.



When the mains circuit input is abnormal, the UPS transfers to battery mode immediately. When the battery voltage is less than shutdown point and bypass is normal in battery mode, the UPS transfers to bypass mode to supply uninterruptible power to the load.

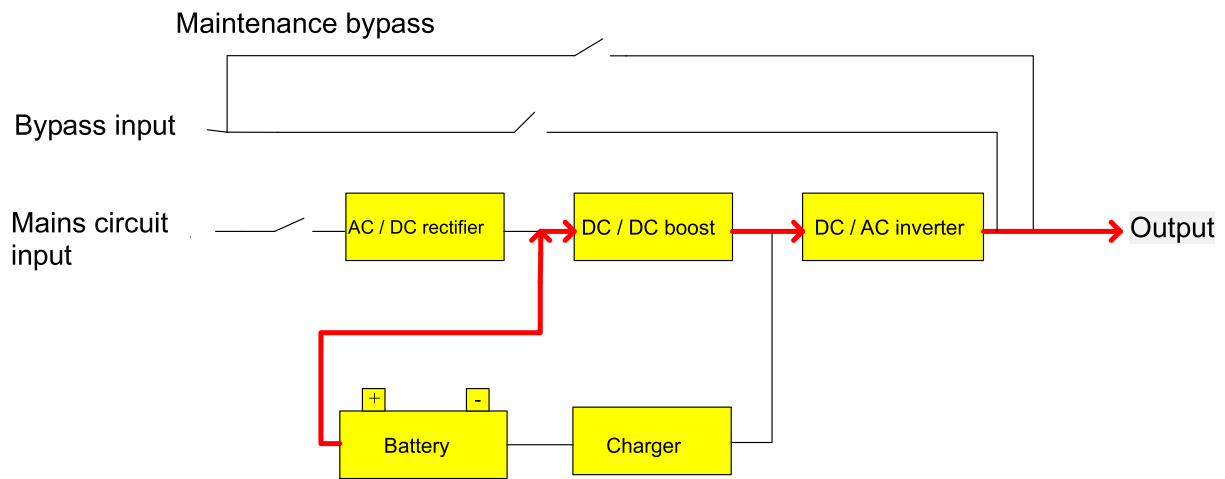

Battery mode / battery self test mode operation process

5.6 ECO mode

LED indicator in ECO mode is as shown in the figure below: the inverter. LED indicator (green) is illuminated and bypass LED indicator (yellow) is illuminated, meanwhile LCD display ECO characters.



When bypass input meets ECO input range and ECO function come to use, the UPS works in ECO mode. At this time bypass supply power to the load, meanwhile rectification, boosting and inverter work normally, and the charger charges the batteries. When bypass input is out of ECO range, the UPS transfers to mains power / battery mode operating.

If bypass input is beyond ECO range for five times within 1 hour, the UPS operates time after time from ECO mode to mains power mode, the UPS will automatically operate in mains power mode and close ECO function.

Note: When use ECO mode and ECO transfers to inverter, the output probably break off 20 ms. For those loads which require strict transfer time, be cautious to choose whether start ECO mode or not. Please contact with supplier or after sales staff if need to set economy control operation.

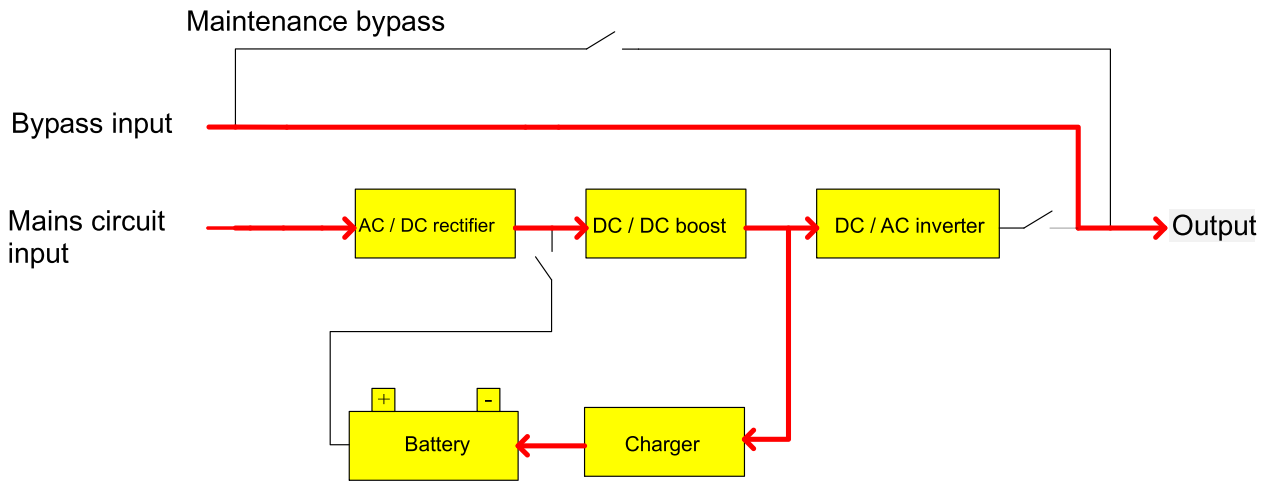

ECO mode operation process

5.7 Fault mode

LED indicator in fault mode is as shown in the figure below: alarm LED Indicator (red) is illuminated, meanwhile LCD displays fault icon and fault code.



When UPS is faulty, the alarm indicator is illuminated, the sound of the UPS buzzer lingers on. According to fault type, fault mode is divided into the fault of cutting off output and the fault of bypass output.

Cut off output after failure in following status:

- Short circuit fault of output A / B / C phases voltage
- Short circuit fault of output AB / BC / CA line voltage
- Beyond 165% overload
- EPO fault of configured cutting off output
- Any fault when bypass is abnormal

Keep bypass supplying power to the load for other faults beyond above status.

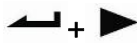
After the UPS enter fault mode, press mute button  to mute the sound (auto cancel mute in one day), meanwhile contact your supplier or after-sales personnel for troubleshooting.

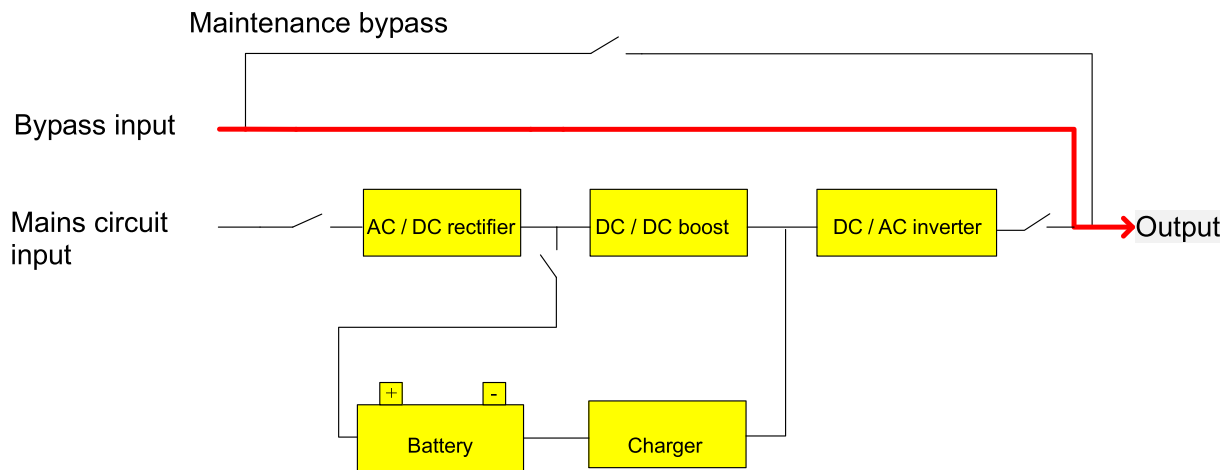

Operation process for fault mode of bypass output

5.8 Maintenance bypass (manual operation)

When UPS is faulty or needs on-site maintenance, qualified personnel will manually switch the UPS to maintenance bypass mode. At this time mains power of bypass input supplies power to the load directly, there is no electricity inside the UPS for maintenance operation.

Note: Make sure the system bypass is normal and not to start frequency conversion, otherwise it may cause power failure or even damage to loads.

If the UPS has no output and needs manual operation on maintenance switch, please ensure to disconnect all input breaker and the UPS display screen is extinguished completely, then put the maintenance switch to “BYPASS” by hand, otherwise it may cause damage to the UPS.

Refer to 4.6.4 for details.

5.9 Test mode

Test mode is specially used for test purpose, it is available to control UPS step-startup and drive test etc. by back-end software.

6 Maintenance and Troubleshooting

6.1 Use and maintenance of battery

Safety instructions:

- The battery life will be shortened with the increase of ambient temperature. Replacing battery regularly can ensure that the UPS operates normally and sufficient backup time.
- If the UPS does not be used for a long time, which should be charged every four to six months. In the areas of high temperature, the battery should be charged and discharged every two months, the time of each charging should not be less than 12 hours.
- Only professionals are allowed to perform battery maintenance.
- Electric shock and short-circuit current may exist in the battery. To avoid electric shock injuries, observe the following warnings when replacing the battery:
 - ✧ Do not wear conductive objects, such as watches, rings, etc.
 - ✧ Use insulation tools;
 - ✧ Wear rubber shoes and gloves;
 - ✧ Do not place metal tools or metal parts on the battery;
 - ✧ Disconnect the loads connected to the battery before removing the battery connection terminal;
- Do not dispose of batteries or battery packs with fire, otherwise it will explode and injure people.
- Non-professionals must not open or damage the battery because the electrolyte in the battery contains dangerous substances, such as strong acids, etc., that can do damage to skin and eyes. If you accidentally contact with the electrolyte, immediately wash with plenty of water and go to the hospital for examination.
- Do not short-circuit the positive and negative anodes of the battery, otherwise it may result in electric shock or fire.
- Do not touch the wiring terminal of the battery. There will be a danger of high

voltage between the battery terminals and ground because the battery circuit is not isolated from the voltage circuit.

The battery maintenance for long time model UPS (It is important to prevent the damage to the precision equipment via performing good maintenance for battery when outage occurs):

- Remove dust and dirt from the battery.
- Check if all the internal wiring of battery is loose or corrosive, if necessary, perform replacement or maintenance.
- Make sure the battery and battery terminals are fastened.

6.2 UPS maintenance

This series of UPS needs less maintenance. The battery of standard model UPS is featured with valve adjustment and low maintenance, which just need to keep its service life via keeping charging. When the UPS is connected to the mains in its normal range, it always charges the battery and provides the functions of overcharge and over discharge protection.

- If the UPS is not used for a long time, it is recommended to charge the UPS every four to six months.
- It is recommended to clean the UPS every four to six months in the event of dusty environments.
- Perform troubleshooting and make the UPS return to normal operation as soon as possible after the fault or alarm occur.
- The operating environment and preservation method have a certain impacts on the service life and reliability of the UPS, do not operate the UPS in the following environments:
 - ✧ Places with high, low temperature and humidity that exceed the specified technical parameters (temperature: 0°C ~ 40°C; relative humidity: 20% ~ 90%);
 - ✧ Places with vibration and easy to be impacted;
 - ✧ Places with metal dust, corrosive substances, salt and flammable gas;

- If the UPS is not used for a long time, it (without battery) must be stored in a dry environment and the storage temperature should be between -25 °C and +55 °C. Before turning on the UPS, the ambient temperature must be raised above 0 °C for more than two hours.

6.3 Maintenance safety precautions

- Disconnect the circuits of the battery and UPS and other battery packs before replacing the battery.
- Do not wear rings, watches, etc.
- Use the screwdriver with an insulated handle, and do not place tools or other metal objects on the battery.
- Do not short-circuit or reverse the positive and negative anodes of the battery.

6.4 Troubleshooting

X is the mode code. The fault alarm information displayed on the LCD consists of the mode code, fault code and alarm code. For example, the output short circuit fault code is X1A; LCD displays 21A when output short circuit occurs in standby mode; LCD displays 31A when output short circuit occurs in bypass mode; LCD displays 41A when output short circuit occurs in mains mode; LCD displays 51A when output short circuit occurs in battery mode; LCD displays 61A when output short circuit occurs in battery self-test mode; LCD displays 81A when output short circuit occurs in frequency conversion mode; LCD displays 91A when output short circuit occurs in ECO mode. The alarm code of abnormal fan is X5F; LCD displays 25F when fan is abnormal in standby mode; LCD displays 35F when fan is abnormal in bypass mode; LCD displays 45F when fan is abnormal in mains mode; LCD displays 55F when fan is abnormal in battery mode; LCD displays 75F when fan is abnormal in battery self-test mode; LCD displays 85F when fan is abnormal in frequency conversion mode; LCD displays 95F when fan is abnormal in ECO mode.

Mode code	Meaning
1	Power-on mode
2	Standby mode
3	Bypass mode
4	Mains mode
5	Battery mode
6	Battery self-test mode
7	Fault mode
8	Frequency conversion mode
9	ECO mode
A	Shutdown mode
B	Test mode

6.4.1 Fault information

LCD display in fault mode is as shown below:

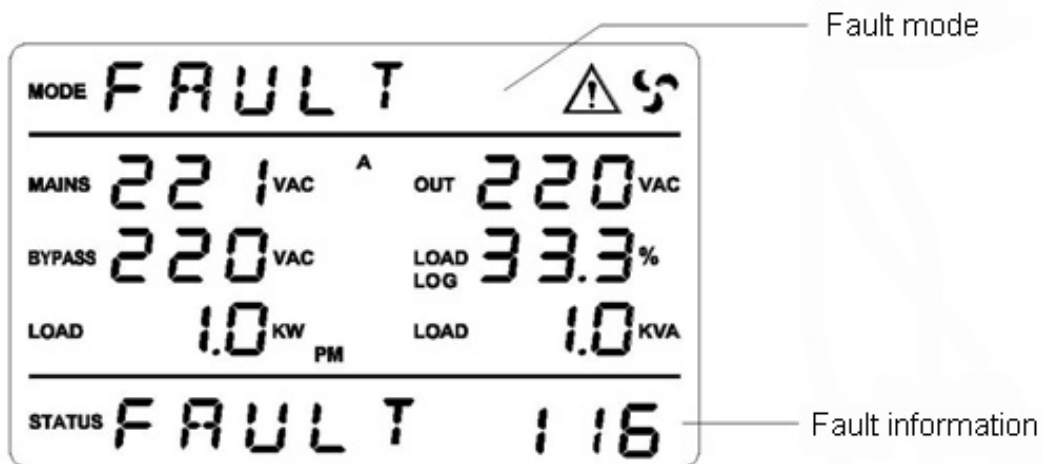

Fault code	Fault content	Solutions
X19 X1A X1B X1C X1D X1E	Output short circuit	Check if there is internal short circuit for the loads connected to each phase; check if there is short circuit for the output part of each inverter power board. After ensuring that the connections are correct and the fault icon is removed, restart the UPS.
X25	Physical address conflict	Check the physical addresses of each UPS and ensure that they are different.
X26	Model is incompatible	Check if the models of each UPS is consistent.
X27	Over temperature inside the UPS	Check if the ambient temperature is too high; check if the fan is abnormal; check if there are objects blocking air-cooling duct.
X28	Overload	Check if there is equipment operating in overload status.
X2D	Bypass wiring error	Check if the bypass phase sequences of each UPS in parallel system are completely consistent; if not, it needs to adjust to be consistent.
X2F	The number of battery is configured incorrectly	Check if the set battery number is consistent with the actual number.
X38	EPO	Under the situation of non-artificial EPO, it needs to check if there is open circuit for the EPO circuit.

Note: Contact the supplier if display screen shows other fault information. After troubleshooting, power-up need to enter menu setting interface to configure CHK OFF, refer to 4.2.9 for operation details.

6.4.2 Alarm information

LCD display in alarm mode is as shown below:

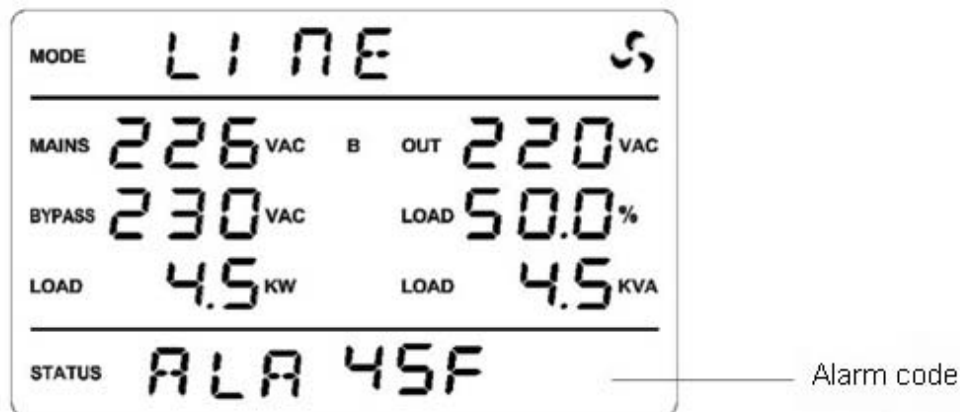

Alarm code	Alarm contents	Solutions
X40	Mains phase sequence error	The mains phase sequence is connected incorrectly, it needs to exchange any two phases or ensure that the phase difference is 120° .
X42	Parallel software version is not compatible	Update the master control program of each UPS to the same version (serial port online programming is available).
X44	Mains default phase	Check if the input wiring of UPS is loose and make sure that the wiring is fastened. Check if the power distribution breaker is trip or damaged and make sure that the breaker is normal and closed.
X45	Mains frequency is abnormal	Check if the input frequency of the UPS is within the normal range with a multimeter.
X46	Mains zero line is not connected	Check if the zero line on the input and output wiring terminal of the UPS is not connected or trip and make sure that the zero line is connected correctly. Check if the power distribution breaker is trip or damaged and make sure that the breaker is normal and closed.

X47	Mains is abnormal	Check if the power grid blackout occurs and make sure that the power grid is normal. Check if the power distribution breaker is trip or damaged and make sure that the breaker is normal and closed.
X48	The phase sequence of bypass and mains is not consistent	Check if the wiring and front-end power distribution of the UPS are normal.
X49	Bypass phase sequence error	The bypass phase sequence is connected incorrectly, it needs to exchange any two phases or ensure that the phase difference is 120° .
X4E	Bypass default phase	Check if the bypass wiring, bypass voltage and bypass power distribution breaker are abnormal.
X4F	Bypass frequency is abnormal	Check if each phase frequency of the UPS bypass voltage is within the set range with a multimeter.
X50	Bypass zero line is not connected	Check if the bypass wiring, bypass voltage and bypass power distribution breaker are abnormal.
X51	Bypass is abnormal	Check if the bypass wiring, bypass voltage and bypass power distribution breaker are abnormal.
X52	Low voltage battery	Disconnect the non-critical loads to extend the power supply time of other critical loads. If the mains power distribution is abnormal, please restore the mains power supply as soon as possible.
X54	Battery is not connected	Check if the battery wiring and battery power distribution breaker are normal; check if the battery is damaged.
X5C	Overload alarm	Disconnect the non-critical loads.

X5F	Fan is abnormal	Check if the fan and its wiring are normal; check if the fan drive module is normal.
X66	Maintenance bypass enable	After the UPS maintenance is completed, reinstall the maintenance bypass cover and the UPS can be powered on normally.
X67	Parallel setting is abnormal	Make sure that the parallel cables are connected normally or cancel parallel mode enable, the UPS operates in single mode.
X6B	The set number of battery in parallel system is not consistent with the actual configuration	Check if the set battery number of each UPS in the parallel system is consistent with the number of actual configuration.
X68	Overload frequently	Check the load capacity and disconnect the non-critical equipment, manually turn on the UPS after clearing alarm via panel or back-end.

The above is a part of the alarm information; please deal with the alarms according to the solutions. Contact the supplier if the alarm cannot be cleared or display screen shows other fault information.